



aerospace
climate control
electromechanical
filtration
fluid & gas handling
hydraulics
pneumatics
process control
sealing & shielding



Instrumentation Quick Coupling Products

Catalog 4220/USA | April 2008



ENGINEERING YOUR SUCCESS.

Introduction

The Parker Hannifin Quick Coupling Division offers a full range of precision quick action couplings for use in the process, power and instrumentation fields.

Quick couplings are used to quickly and easily connect and disconnect rigid or flexible tubing to hose or pipe—without the use of tools. They are available in straight-through (no valving), single shut-off (valving in the coupler half only), and double shut-off (valving in both the coupler and nipple halves) configurations for maximum flexibility. With sealing integrity to 1×10^{-6} cc/sec of helium at 50 millitor, Parker Quick Couplings are ideal for use with a wide range of media in vacuum or high pressure applications.

Available end configurations include: Male and Female Pipe Thread, A-LOK® and CPI tube ends, 37° Flare, Hose Barb, and Bulkhead fittings. Stainless Steel couplings feature Fluorocarbon seals as standard. Brass Couplings are equipped with Nitrile seals. Ethylene Propylene, Perfluoroelastomer, and other seal materials are also available upon request.

Consult the Safety Guide in the back of this catalog for more information on the selection and use of quick action couplings.

Parker Quick couplings designed for instrumentation applications are built to stringent standards and meticulously tested for sealing integrity. Applications for these precision couplings include, but are not limited to the following:

- All types of instruments
- Laboratory equipment
- Vacuum systems
- Chemical research
- Gas supply systems
- Portable analyzers
- Control panels
- Hydraulic and pneumatic systems
- Medical equipment
- Food processing equipment
- Calibration systems
- Test stands
- Gas chromatographs
- Micro-contamination devices

Note: Flow charts in this catalog reflect actual test data. Flow tests were conducted using ANSI standard test procedures.



WARNING

FAILURE OR IMPROPER SELECTION OR IMPROPER USE OF THE PRODUCTS AND/OR SYSTEMS DESCRIBED HEREIN OR RELATED ITEMS CAN CAUSE DEATH, PERSONAL INJURY AND PROPERTY DAMAGE.

This document and other information from Parker Hannifin Corporation, its subsidiaries and authorized distributors provide product and/or system options for further investigation by users having technical expertise. It is important that you analyze all aspects of your application and review the information concerning the product or system in the current product catalog. Due to the variety of operating conditions and applications for these products or systems, the user, through its own analysis and testing, is solely responsible for making the final selection of the products and systems and assuring that all performance, safety and warning requirements of the application are met.

The products described herein, including without limitation, product features, specifications, designs, availability and pricing, are subject to change by Parker Hannifin Corporation and its subsidiaries at any time without notice.

Offer of Sale

The items described in this document are hereby offered for sale by Parker Hannifin Corporation, its subsidiaries or its authorized distributors. This offer and its acceptance are governed by the provisions stated in the "Offer of Sale."

Table of Contents

Quick Coupling Products



Table Of Contents	1	Thermoplastic Quick Couplings	21
Fluid Quick Couplings	3	Coupling Selection Guide	22
Coupling Selection Guide	4	PF Series	23
Non-Spill Couplings	5	Couplers	24
FS Series	5	Nipples.....	24
Couplers	6	PF Series Dust Caps & Plugs	24
Nipples	7	Spectrum Series	25
FS Series Dust Caps & Plugs	8	Couplers	26
FS Series Repair Kits.....	8	Nipples: Valved	27
CPI Series	9	Nipples: Non Valved.....	28
Couplers	10	Pneumatic Quick Couplings	29
Nipples: Valved	11	Coupling Selection Guide	30
Nipples: Non Valved.....	12	Pneumatic Couplings	31
CPI Series Coupler and Nipple Protectors.....	13	HF Series	31
Ordering Information	13	Couplers	32
High Flow Couplings	14	Nipples	32
ST Series	14	Industrial Interchange Nipples	35
Couplers	15	DM Series	37
Nipples.....	16	Couplers	38
General Purpose Couplings	17	Nipples.....	38
60 Series	17	Appendices	39
Couplers and Nipples 1/8" – 1".....	19	Fluid Compatibility Chart	40
Couplers and Nipples 1 1/2" – 2 1/2".....	20	Glossary Of Terms	46
60 Series Dust Caps & Plugs.....	19	Safety Guide	47
Optional Seals.....	20	Offer Of Sale	49
60 Series Repair Kits	20		

Fluid Quick Couplings

	Valving	Body Size	Material*				Locking Mechanism	Std. Seal Material	Temp Range**	Rated Pressure
			Br	SS	S	P				
Non-Spill										
FS Series	Flush Face	1/4" to 1"	•				Ball	Fluorocarbon	-20° to +400° F	2000 PSI
Instrumentation										
CPI Series		1/4" to 1/2"	•				Ball	Fluorocarbon	-20° to +400° F	2000 - 3000 PSI
High Flow										
ST Series	None	1/8 to 1 1/2"	•	•			Ball	Nitrile	-40° to +250° F	2500 to 6700 PSI
General Purpose										
60 Series	Poppet	1/8 - 2 1/2"	•	•	•		Ball	Nitrile	-40° to +250° F	1000 to 5000 PSI

* See Fluid Compatibility chart and/or consult factory for questions regarding proper material for specific applications.

CODE: Br = Brass; SS = Stainless Steel; S = Steel; P = Plastic

**Temperature Range for standard seal material.



Applications

Parker FS Series couplings virtually eliminate fluid loss upon disconnection, and minimize air inclusion during connections. They are ideal for use where spillage may cause undesirable conditions or constitute a safety hazard. The FS Series couplings have double shut-off flush mating valves that are suitable for sealing off media in chemical processing, chemical dispensing, food processing, and other corrosive applications. Working pressures to 2000 psi.

Note: Protective dust plugs and caps play a crucial role in the life of a quick coupling and no purchase of a hydraulic quick coupling is complete without the selection of an appropriate dust plug and cap. See pages noted in Table of Contents for dust plugs and caps for the Parker full line of hydraulic couplings.

Specifications

Body Size	1/4"	3/8"	1/2"	3/4"	1"
Rated Pressure (PSI)	2000	2000	2000	2000	2000
Rated Flow (GPM)	3	6	12	26	50
Spillage (ML) (max. per disconnect)	.015	.015	.020	.150	.250
Air Inclusion (ML) (max. per connect)	.010	.020	.070	.100	.182
CV	0.9	1.8	3.0	7.0	10.1

Temperature Range (continuous)		
Part No. Seal Suffix	O-Ring Compound	Temp°F Rating
None*	Fluorocarbon	-15 to 400
E5	Ethylene Propylene (EPR)	-65 to 300
E1	Nitrile	-40 to 250
E47	Perfluoroelastomer (Consult Factory)	-20 to 600

*Fluorocarbon is standard seal.

Features

- Simple to operate: Push to connect, pull on knurled sleeve to disconnect.
- Flush face valves exhibit minimal spillage upon disconnect and minimal air inclusion upon connect.
- Superior locking ball design – a large number of locking balls distribute the workload better and allow for some rotation between the male and female halves of the coupling under pressure.
- Excellent flow vs pressure drop characteristics when compared with other low spill quick couplings.
- Material construction is 316 stainless steel with Fluorocarbon seals as standard.
- Wide range of seal materials available.
- Repair kits available to replace critical elastomer seals (all sizes).
- Coupling sealing integrity is approximately 1 x 10⁻⁶ std. cc/sec. Helium under 50 millitorr of vacuum.

Materials of Construction

Machined Parts:	Stainless Steel, AISI type 316
Springs:	Stainless Steel, AISI type 316
Locking Balls:	1/4" - 302 SS; 3/8" - 1" - Tungsten Carbide
Backup Washers:	PTFE
Elastomer Seals:	Fluorocarbon is standard. Wide range is available.

Performance Flow Data

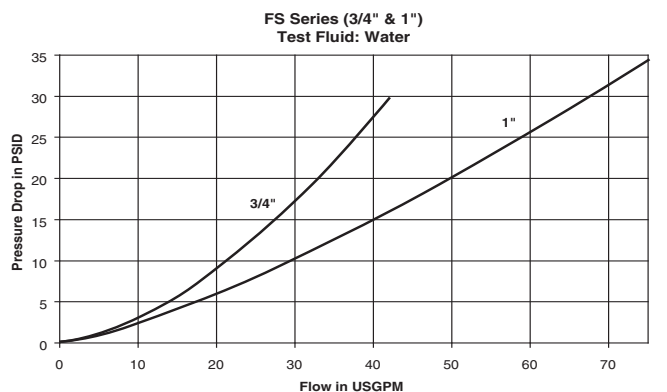
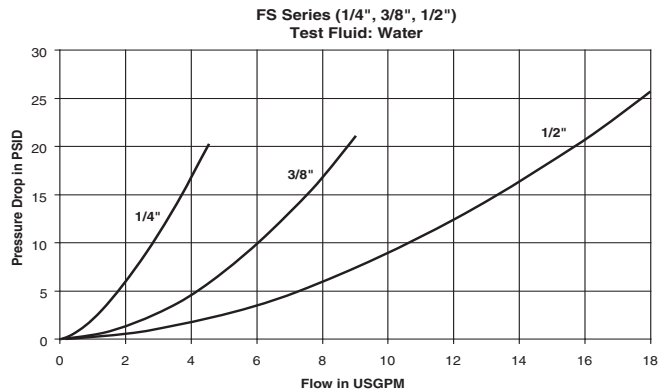

Couplers

Female Pipe Thread

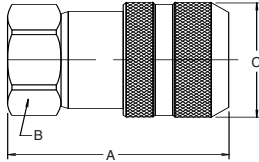

Body Size (in.)	Part No.	Thread Size	Overall Length	Hex Size	Largest Diameter	Wt. (LB.) P/Piece
3/8	FS-371-6FP	3/8-18 NPT	2.52	1.06	1.30	0.58
1/2	FS-501-8FP	1/2-14 NPT	2.74	1.38	1.58	0.92
1/2	FS-501-10FO	7/8-14 UNF	2.86	1.38	1.58	0.96
3/4	FS-751-12FP	3/4-14 NPT	3.63	1.75	1.99	2.00
3/4	FS-751-12FO	1-1/16-12 UNF	3.73	1.75	1.99	2.12
1	FS-1001-16FP	1-11 1/2 NPT	4.14	1.87	2.25	2.76
1	FS-1001-16FO	1-5/16-12 UNF	4.24	1.87	2.25	2.80

Female Pipe Thread

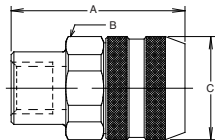

Body Size (in.)	Part No.	Thread Size	Overall Length	Hex Size	Largest Diameter	Wt. (LB.) P/Piece
1/4	FS-251-4FP	1/4-18 NPT	1.79	1.00	1.06	0.25

Male Pipe Thread

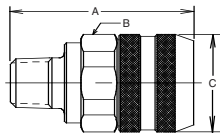

Body Size (in.)	Part No.	Thread Size	Overall Length	Hex Size	Largest Diameter	Wt. (LB.) P/Piece
1/4	FS-251-4MP	1/4-18 NPT	2.00	1.00	1.06	0.25

SAE Straight Thread

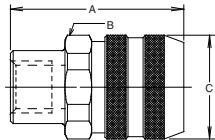

Body Size (in.)	Part No.	Thread Size	Overall Length	Hex Size	Largest Diameter	Wt. (LB.) P/Piece
1/4	FS-251-6FO	9/16-18 UNF	1.92	1.00	1.06	0.24
3/8	FS-371-8FO	3/4-16 UNF	2.83	1.12	1.30	0.63

Tube Fitting Connection

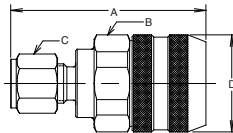

Body Size (in.)	Part No.	Thread Size	Overall Length	Hex Size	Hex Size	Largest Diameter	Wt. (LB.) P/Piece
1/4	FS-251-4MZ	1/4" CPI Tube	2.14	1.00	0.56	1.06	-

Bulkhead W/ Tube Fitting

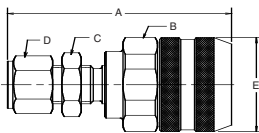

Body Size (in.)	Part No.	Thread Size	Overall Length	Hex Size	Hex Size	Hex Size	Largest Diameter	Wt. (LB.) P/Piece
1/4	FS-251-4BZ	1/4" CPI Tube	2.52	1.00	0.62	0.56	1.06	-

Quick Coupling Products

Non-Spill Couplings FS Series

Nipples

Female Pipe Thread

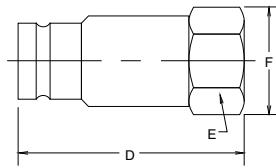

Body Size (in.)	Part No.	Thread Size	Overall Length	Hex Size	Largest Diameter	Wt. (LB.) P/Piece
			D	E	F	
3/8	FS-372-6FP	3/8-18 NPT	2.31	0.94	1.08	0.26
1/2	FS-502-8FP	1/2-14 NPT	2.75	1.12	1.30	0.44
1/2	FS-502-10FO	7/8-14 UNF	2.85	1.12	1.30	0.48
3/4	FS-752-12FP	3/4-14 NPT	3.38	1.50	1.73	1.02
3/4	FS-752-12FO	1-1/16-12 UNF	3.38	1.50	1.73	1.14
1	FS-1002-16FP	1-11 1/2 NPT	3.89	1.87	2.17	1.60
1	FS-1002-16FO	1-5/16 12 UNF	3.89	1.87	2.17	1.64

Female Pipe Thread

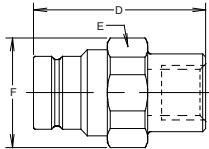

Body Size (in.)	Part No.	Thread Size	Overall Length	Hex Size	Largest Diameter	Wt. (LB.) P/Piece
			D	E	F	
1/4	FS-252-4FP	1/4-18 NPT	1.66	1.00	1.06	0.18

Male Pipe Thread

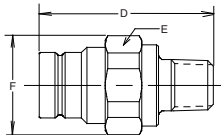

Body Size (in.)	Part No.	Thread Size	Overall Length	Hex Size	Largest Diameter	Wt. (LB.) P/Piece
			D	E	F	
1/4	FS-252-4MP	1/4-18 NPT	1.87	1.00	1.06	0.18

SAE Straight Thread

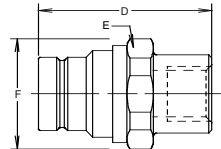

Body Size (in.)	Part No.	Thread Size	Overall Length	Hex Size	Largest Diameter	Wt. (LB.) P/Piece
			D	E	F	
1/4	FS-252-6FO	9/16-18 UNF	1.66	1.00	1.06	0.17
3/8	FS-372-8FO	3/4-16 UNF	2.45	1.06	1.19	0.30

Tube Fitting Connection

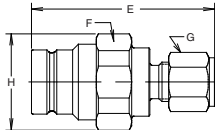

Body Size (in.)	Part No.	Thread Size	Overall Length	Hex Size	Hex Size	Largest Diameter	Wt. (LB.) P/Piece
			E	F	G	H	
1/4	FS-252-4MZ	1/4" CPI Tube	2.02	1.00	0.56	1.06	-

Bulkhead W/ Tube Fitting

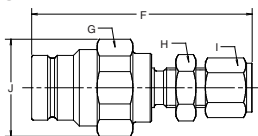

Body Size (in.)	Part No.	Thread Size	Overall Length	Hex Size	Hex Size	Hex Size	Largest Diameter	Wt. (LB.) P/Piece
			F	G	H	I	J	
1/4	FS-252-4BZ	1/4" CPI Tube	2.40	1.00	0.62	0.56	1.06	-

Quick Coupling Products

Non-Spill Couplings FS Series

Dust Caps and Plugs



Protective dust plugs and caps play a crucial role in the life of a quick coupling and no purchase of a hydraulic quick coupling is complete without the selection of an appropriate dust plug and cap.

Body Size (in.)	Dust Plug Part No.	Dust Cap Part No.
1/4*	FR-25	FR-25
3/8	NR-50	NR-37
1/2	FR-501	FR-502
3/4	FR-751	FR-752
1	FR-1001	FR-1002

Dust Plug:
Used on Coupler
(female half)

Dust Cap:
Used on Nipple
(male half)

* FR-25 fits both halves

FS Series Repair Kits



Repair kits are available for both coupler and nipple half of FS couplings.

Kits include replacement elastomer seals and instructions to perform rebuild. Spline tool must be ordered separately to accomplish coupler half repair.

Other tools required: Vise, Allen Wrench and Open End Wrench

FS Repair Kits	
TOOL Spline tool for Coupler (female half) Repair	Replacement Seals
	E5 Ethylene Propylene (EPR) E35 Perfluoroelastomer (Contact the Division) No Suffix Standard Fluorocarbon Seals

Nipple Repair Kits

Size	1/4" Nipple	3/8" Nipple	1/2" Nipple	3/4" Nipple	1" Nipple
Part No.	FS-252-KIT FS-252-KIT-E5 FS-252-KIT-E35	FS-372-KIT FS-372-KIT-E5 FS-372-KIT-E35	FS-502-KIT FS-502-KIT-E5 FS-502-KIT-E35	FS-752-KIT FS-752-KIT-E5 FS-752-KIT-E35	FS-1002-KIT FS-1002-KIT-E5 FS-1002-KIT-E35

Coupler Repair Kits

Size	1/4" Coupler	3/8" Coupler	1/2" Coupler	3/4" Coupler	1" Coupler
Part No.	Not Available	FS-371-KIT FS-371-KIT-E5 FS-371-KIT-E35 FF/FS-371-TOOL	FS-501-KIT FS-501-KIT-E5 FS-501-KIT-E35 FS-501-TOOL	FS-751-KIT FS-751-KIT-E5 FS-751-KIT-E35 FF/FS751-TOOL	FS-1001-KIT FS-1001-KIT-E5 FS-1001-KIT-E35 FF/FS-1001-TOOL



CPI Series Features

- Simple push-pull action to connect and disconnect lines—no tools required.
- Reliable, leak-tight O-ring seals for vacuum or pressure systems.
- Couplers and nipples are available valved or unvalved. Valves automatically open when connected and shut off when disconnected to minimize the loss of liquids or gases.
- Positive valve stops prevent flow checking.
- Valve guide positively aligns valve with seat to prevent leakage.
- Durable ball-locking mechanism assures reliable connection while distributing the load and providing alignment and swiveling action.
- CPI Series couplers and valved nipples are 100% factory leak tested to 1×10^{-3} cc/s.

Specifications

Vacuum Rating: Parker CPI Series will handle vacuums up to 50 millitorr or .05 mm of Hg absolute pressure.

Rated Working Pressure (PSI)			
Body Size	1/4"	3/8"	1/2"
Connected	3000	1500	750
Disconnected	3000	1500	750
Connect Under Pressure*	250	250	250

*See Glossary of Terms

Materials of Construction

Stainless Steel Products

Machined Parts:	Stainless Steel AISI type 316
Springs:	Stainless Steel AISI type 302
Locking Balls:	Stainless Steel AISI type 302
Retaining Rings:	Stainless Steel AISI type 302
Seals:	Fluorocarbon is standard Other materials available

CPI Series Performance

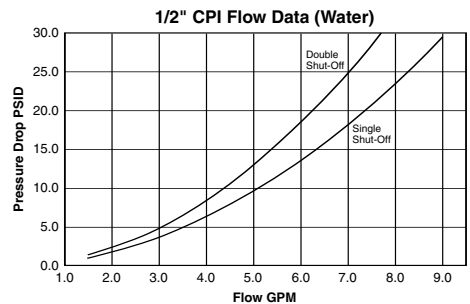
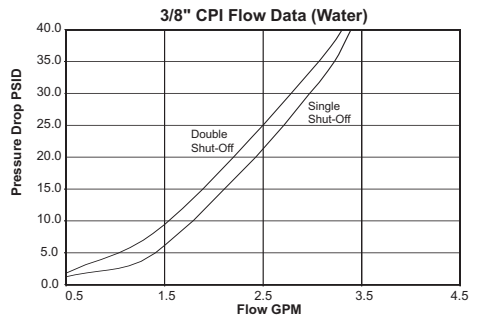
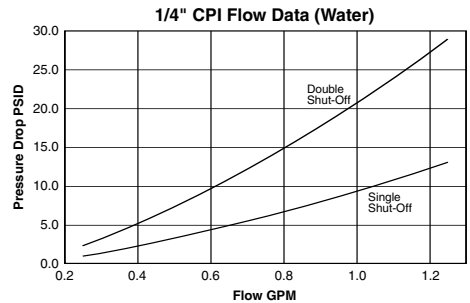

Quick Coupling Products

Instrumentation Couplings CPI Series – Couplers

Tube Ends

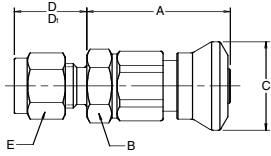

Body Size	Part No. Stainless Steel	Tube Size	A	Hex B	Dia. C	D	D1	Hex E
1/4	2*-Q4CY-SSP	1/8	1.44	.62	.86	.61	.60	.44
1/4	4*-Q4CY-SSP	1/4	1.41	.62	.86	.70	.70	.56
3/8	6*-Q6CY-SSP	3/8	1.63	.75	.98	.78	.76	.69
1/2	8*-Q8CY-SSP	1/2	2.03	.94	1.17	.91	.87	.88

* Substitute "Z" for CPI or "A" for A-LOK®

Male Pipe

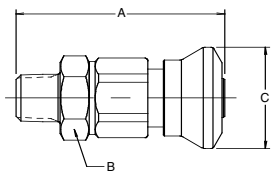

Body Size	Part No. Stainless Steel	Thread Size/NPT	A	Hex B	Dia. C
1/4	2M-Q4CY-SSP	1/8	1.78	.62	.86
1/4	4M-Q4CY-SSP	1/4	1.97	.62	.86
3/8	4M-Q6CY-SSP	1/4	2.19	.75	.98
3/8	6M-Q6CY-SSP	3/8	2.19	.75	.98
1/2	8M-Q8CY-SSP	1/2	2.78	.94	1.17

Female Pipe

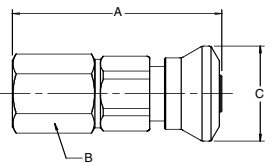

Body Size	Part No. Stainless Steel	Thread Size/NPT	A	Hex B	Dia. C
1/4	2F-Q4CY-SSP	1/8	1.91	.62	.86
1/4	4F-Q4CY-SSP	1/4	2.22	.75	.86
3/8	4F-Q6CY-SSP	1/4	2.36	.75	.98
3/8	6F-Q6CY-SSP	3/8	2.38	.88	.98
1/2	8F-Q8CY-SSP	1/2	3.03	1.06	1.17

Bulkhead

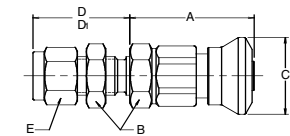

Body Size	Part No. Stainless Steel	Tube Size	A	Hex B	Dia. C	D	D1	Hex E
1/4	4*H-Q4CY-SSP	1/4	1.41	.62	.86	1.09	1.09	.56
3/8	6*H-Q6CY-SSP	3/8	1.63	.75	.98	1.20	1.18	.69
1/2	8*H-Q8CY-SSP	1/2	2.03	.94	1.17	1.38	1.34	.88

* Substitute "Z" for CPI or "A" for A-LOK®

Push-Lok

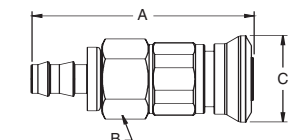

Body Size	Part No. Stainless Steel	Hose I.D.	A	Hex B	Dia. C
1/2	6PL-Q8CY-SSP	3/8	3.00	.94	1.17

Quick Coupling Products

Instrumentation Couplings CPI Series – Valved Nipples

Tube Ends

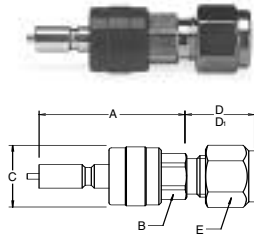

Body Size	Part No. Stainless Steel	Tube Size	A	Hex B	Dia. C	D	D1	Hex E
1/4	2*-Q4VY-SS	1/8	2.45	.44	.62	.61	.60	.44
1/4	4*-Q4VY-SS	1/4	1.95	.44	.62	.70	.70	.56
3/8	6*-Q6VY-SS	3/8	2.00	.56	.74	.78	.76	.69
1/2	8*-Q8VY-SS	1/2	2.45	.75	.88	.91	.87	.88

* Substitute "Z" for CPI or "A" for A-LOK®

Male Pipe

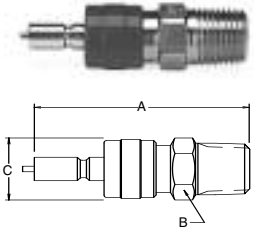

Body Size	Part No. Stainless Steel	Thread Size/NPT	A	Hex B	Dia. C
1/4	2M-Q4VY-SS	1/8	2.58	.44	.62
1/4	4M-Q4VY-SS	1/4	2.24	.56	.62
3/8	4M-Q6VY-SS	1/4	2.15	.56	.74
3/8	6M-Q6VY-SS	3/8	2.30	.75	.74
1/2	8M-Q8VY-SS	1/2	2.84	.88	.88

Female Pipe

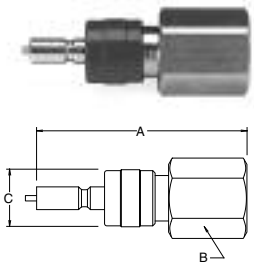

Body Size	Part No. Stainless Steel	Thread Size/NPT	A	Hex B	Dia. C
1/4	2F-Q4VY-SS	1/8	2.04	.56	.62
1/4	4F-Q4VY-SS	1/4	2.25	.75	.62
3/8	4F-Q6VY-SS	1/4	2.28	.75	.74
1/2	8F-Q8VY-SS	1/2	2.87	1.06	.88

Push-Lok

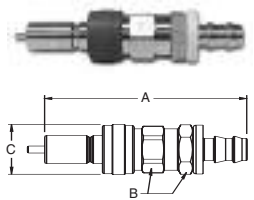

Body Size	Part No. Stainless Steel	Hose I.D.	A	Hex B	Dia. C
1/2	6PL-Q8VY-SS	3/8	3.56	.75	.88

Quick Coupling Products

Instrumentation Couplings CPI Series – Non-Valved Nipples

Tube Ends

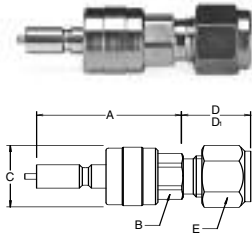

Body Size	Part No. Stainless Steel	Tube Size	A	Hex B	Dia. C	D	D1	Hex E
1/4	2*-Q4P-SS	1/8	2.45	.44	.62	.61	.60	.44
1/4	4*-Q4P-SS	1/4	1.95	.44	.62	.70	.70	.56
3/8	6*-Q6P-SS	3/8	2.00	.56	.74	.78	.76	.69
1/2	8*-Q8P-SS	1/2	2.45	.75	.88	.91	.87	.88

* Substitute "Z" for CPI or "A" for A-LOK®

Male Pipe

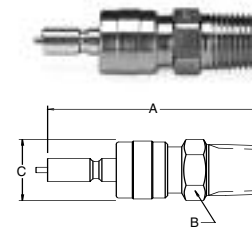

Body Size	Part No. Stainless Steel	Thread Size/NPT	A	Hex B	Dia. C
1/4	2M-Q4P-SS	1/8	2.58	.44	.62
1/4	4M-Q4P-SS	1/4	2.24	.56	.62
3/8	4M-Q6P-SS	1/4	2.15	.56	.74
3/8	6M-Q6P-SS	3/8	2.30	.75	.74
1/2	8M-Q8P-SS	1/2	2.84	.88	.88

Female Pipe

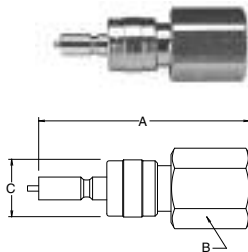

Body Size	Part No. Stainless Steel	Thread Size/NPT	A	Hex B	Dia. C
1/4	2F-Q4P-SS	1/8	2.04	.56	.62
1/4	4F-Q4P-SS	1/4	2.25	.75	.62
3/8	4F-Q6P-SS	1/4	2.28	.75	.74
1/2	8F-Q8P-SS	1/2	2.87	1.06	.88

Coupler Protectors

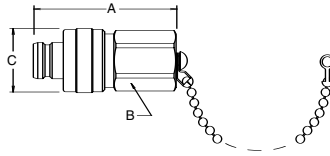

Body Size	Part Number	A	Hex B	Dia. C
1/4	CP-Q4C-SS	1.75	.44	.62
3/8	CP-Q6C-SS	1.78	.56	.74
1/2	CP-Q8C-SS	1.94	.69	.88

Protectors are not pressure containing

Nipple Protectors

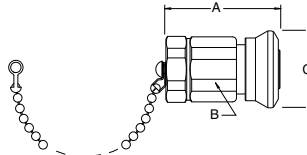

Body Size	Part Number	A	Hex B	Dia. C
1/4	VP-Q4V-SSP	1.37	.62	.86
3/8	VP-Q6V-SSP	1.44	.75	.98
1/2	VP-Q8V-SSP	1.72	.94	1.17

Protectors are not pressure containing

Ordering Information

4 M - Q 4 C N - SS P

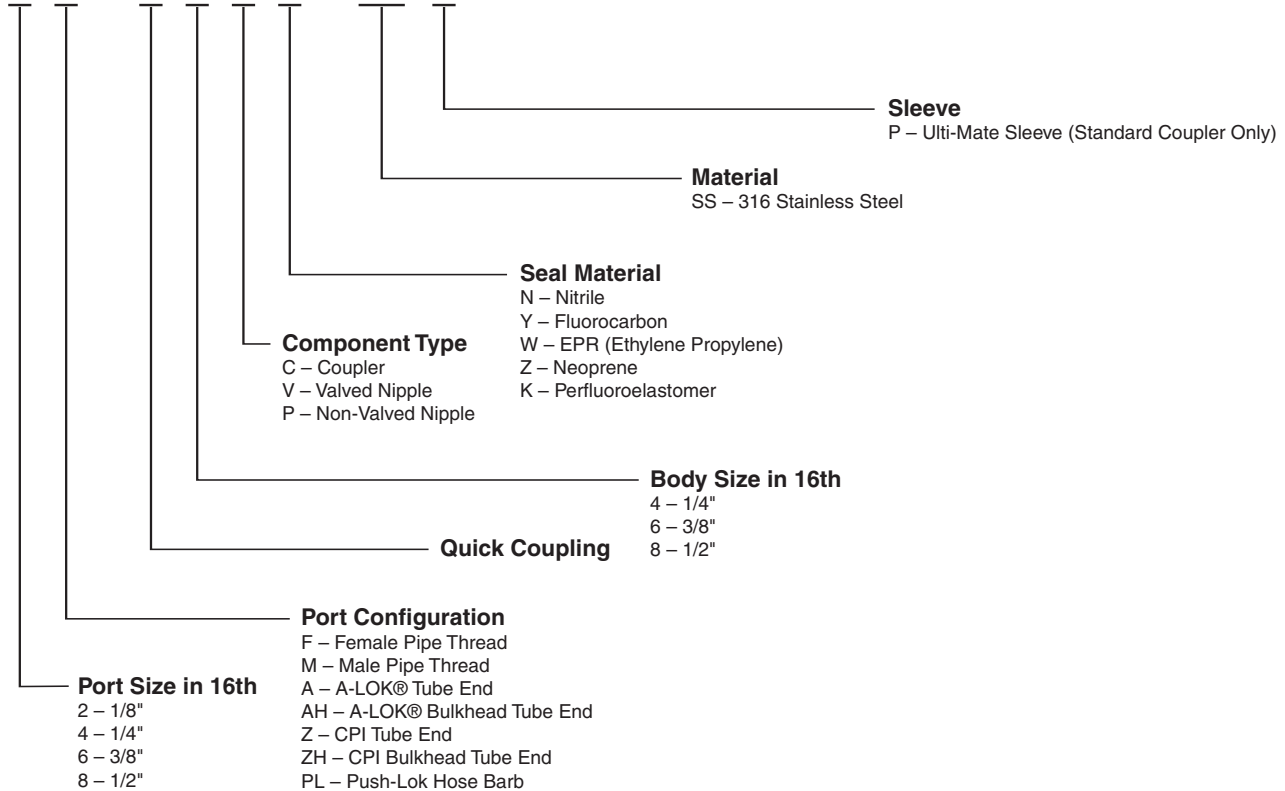

Note: Some options are non-standards and will need to be quoted on special basis.



Applications

The Parker ST Series are non-valved couplings for applications where maximum flow is required. Their smooth, open bore offers the lowest pressure drop of any quick coupling design and is ideal for applications such as high-pressure water and steam washers, carpet cleaners and mold coolant lines. They are often used in food processing, on fluid and dye transfer lines.

Specifications

Body Size	1/8	1/4	3/8	1/2	3/4	1	1-1/4	1-1/2
Rated Pressure (PSI)								
Brass	2500	5200	2700	2200	1700	1200	1700	1400
Stainless Steel	4200	6700	5500	3000	3000	1700	—	—
Rated Flow	3	6	12	12	28	50	76	100
Temperature Range (std seals)	-40° to +250°F							

Special Order Information

All sizes of ST Series can be furnished with locking sleeves. Place suffix letters "SL" (Sleeve-Lok) after regular catalog numbers. Example: SST-4MSL. Standard seal material is Nitrile. Ethylene Propylene, Fluorocarbon, or Neoprene seals are available upon request. See Fluid Compatibility Chart for recommendations.

Performance

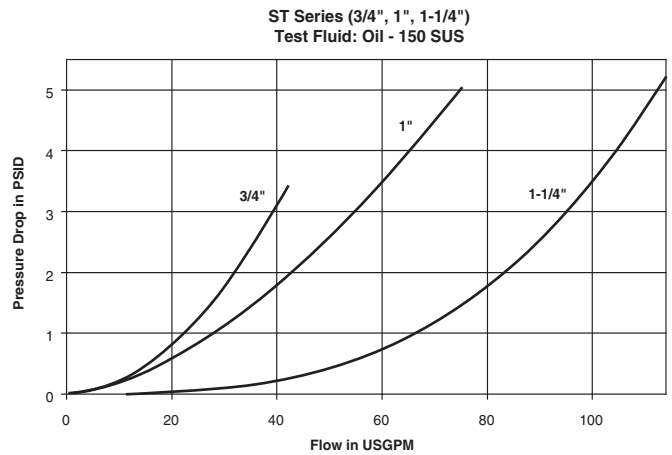
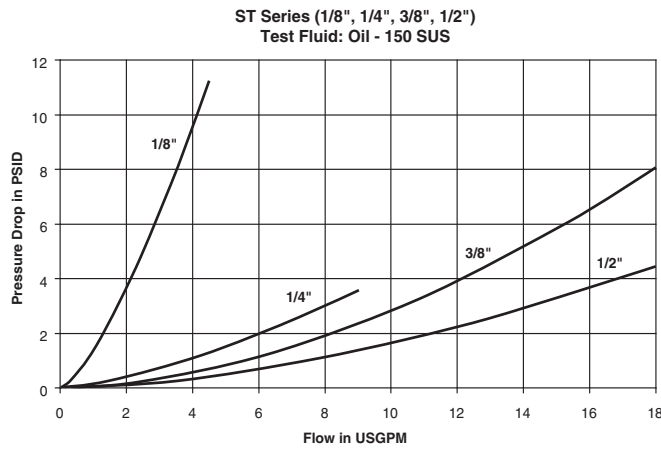

Quick Coupling Products

High Flow Couplings ST Series

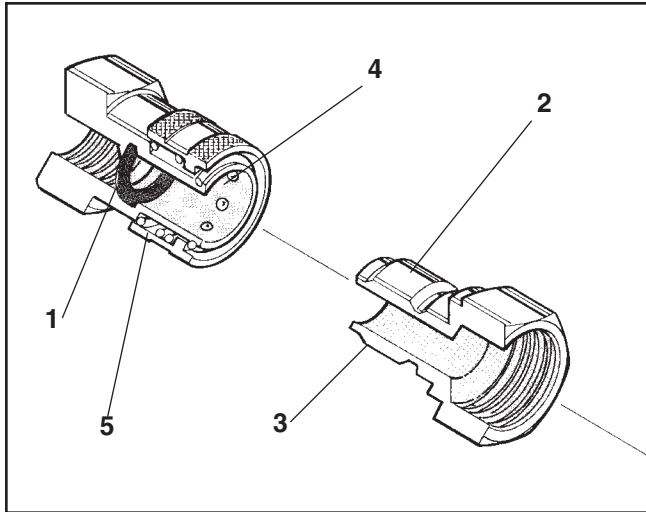

Features

1. The smooth, open bore with no valving in either half offers minimal pressure drop and allows easy cleaning in applications where the same lines are used for more than one media.
2. ST couplers and nipples are machined from solid barstock, providing a quality coupling that is durable. ST couplers are available in brass and 303 and 316 stainless steel as standard product materials.
3. ST nipples are available in 303 stainless steel, 316 stainless steel, brass, and carbon steel.
4. The ST series is an interchange coupling that dimensionally and functionally interchanges with similar couplings made by other manufacturers.

Couplers

Female Pipe Thread

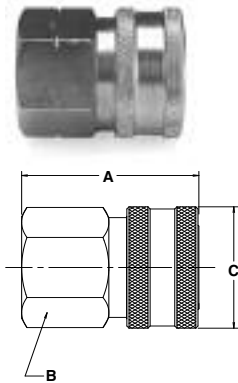

Body Size (in.)	Part No. Brass	Wt. (LB.) P/Piece	Part No. Type 303 Stainless	Wt. (LB.) P/Piece	Part No. Type 316 Stainless	Wt. (LB.) P/Piece	Thread Size NPTF	Dimensions (in.)		
								Overall Length	Wrench Flats	Largest Diameter
								A	B	C
1/8	BST-1	0.06	SST-1	0.05	SSST-1Y*	0.05	1/8-27	1.06	0.56	0.69
1/4	BST-2	0.17	SST-2	0.15	SSST-2Y*	0.15	1/4-18	1.54	0.81	0.94
3/8	BST-3	0.26	SST-3	0.24	SSST-3Y*	0.24	3/8-18	1.59	1.00	1.16
1/2	BST-4	0.59	SST-4	0.37	-	-	1/2-14	1.98	1.13	1.30
3/4	BST-6	0.62	SST-6	0.57	-	-	3/4-14	2.15	1.44	1.66
1	BST-8	0.99	SST-8	0.93	-	-	1-11 1/2	2.43	1.75	2.02
1-1/4	BST-10	1.38	-	-	-	-	1 1/4-11 1/2	2.44	2.00	2.51
1-1/2	BST-12	1.42	-	-	-	-	1 1/2-11 1/2	2.88	2.50	3.00

Contact division for BSPP port availability

* Fluorocarbon Seals are standard with 316 Stainless Steel

Male Pipe Thread

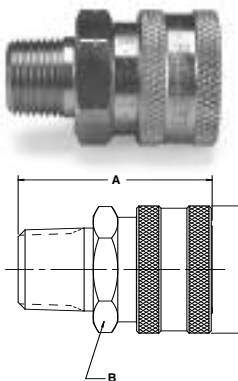

Body Size (in.)	Part No. Brass	Wt. (LB.) P/Piece	Part No. Type 303 Stainless	Wt. (LB.) P/Piece	Part No. Type 316 Stainless	Wt. (LB.) P/Piece	Thread Size NPTF	Dimensions (in.)		
								Overall Length	Wrench Flats	Largest Diameter
								A	B	C
1/8	BST-1M	0.05	SST-1M	0.05	SSST-1MY*	0.05	1/8-27	1.06	0.56	0.69
1/4	BST-2M	0.16	SST-2M	0.16	SSST-2MY*	0.16	1/4-18	1.69	0.81	0.81
3/8	BST-3M	0.25	SST-3M	0.21	SSST-3MY*	0.21	3/8-18	1.75	1.00	1.16
1/2	BST-4M	0.34	SST-4M	0.31	-	-	1/2-14	1.94	1.13	1.30
3/4	BST-6M	-	SST-6M	0.49	-	-	3/4-14	2.17	1.44	1.66
1	BST-8M	0.85	SST-8M	0.08	-	-	1-11 1/2	2.53	1.75	2.02

Contact division for BSPT port availability

* Fluorocarbon Seals are standard with 316 Stainless Steel

Quick Coupling Products

High Flow Couplings ST Series

Nipples

Female Pipe Thread

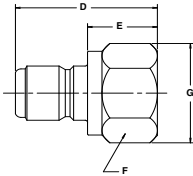

Body Size (in.)	Part No. Brass	Wt. (LB.) P/Piece	Part No. Steel	Wt. (LB.) P/Piece	Part No. Type 303 Stainless		Part No. Type 316 Satinless		Thread Size NPTF	Dimensions (in.)				
					Wt. (LB.) P/Piece	Wt. (LB.) P/Piece	Wt. (LB.) P/Piece	Wt. (LB.) P/Piece		Overall Length	Exposed Length	Hex Size	Largest Dia.	
											D	E	F	G
1/8	BST-N1	0.03	ST-N1	0.03	SST-N1	0.02	SSST-N1*	0.02	1/8-27	.98	0.57	0.56	0.65	
1/4	BST-N2	0.07	ST-N2	0.07	SST-N2	0.07	SSST-N2*	0.07	1/4-18	1.46	0.74	0.75	0.87	
3/8	BST-N3	0.12	ST-N3	0.11	SST-N3	0.11	SSST-N3*	0.11	3/8-18	1.62	0.96	1.38	1.59	
1/2	BST-N4	0.23	ST-N4	0.21	SST-N4	0.21	-	-	1/2-14	1.85	0.95	1.13	1.30	
3/4	BST-N6	0.33	ST-N6	0.32	SST-N6	0.32	-	-	3/4-14	2.15	1.09	1.38	1.59	
1	BST-N8	0.52	ST-N8	0.49	SST-N8	0.48	-	-	1-11 1/2	2.35	1.18	1.63	1.88	
1 1/4	BST-N10	0.85	-	-	-	-	-	-	1 1/4-11 1/2	2.38	1.11	2.00	2.31	
1 1/2	BST-N12	1.45	-	-	-	-	-	-	1 1/2-11 1/2	2.81	1.17	2.38	2.74	

Contact division for BSPT port availability

* Fluorocarbon Seals are standard with 316 Stainless Steel

Nipples

Male Pipe Thread

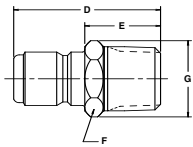

Body Size (in.)	Part No. Brass	Wt. (LB.) P/Piece	Part No. Steel	Wt. (LB.) P/Piece	Part No. Type 303 Stainless		Part No. Type 316 Satinless		Thread Size NPTF	Dimensions (in.)				
					Wt. (LB.) P/Piece	Wt. (LB.) P/Piece	Wt. (LB.) P/Piece	Wt. (LB.) P/Piece		Overall Length	Exposed Length	Hex Size	Largest Dia.	
											D	E	F	G
1/8	BST-N1M	0.02	ST-N1M	0.02	SST-N1M	0.02	SSST-N1M*	0.02	1/8-27	1.04	0.63	0.44	0.51	
1/4	BST-N2M	0.06	ST-N2M	0.05	SST-N2M	0.05	SSST-N2M*	0.05	1/4-18	1.53	0.81	0.56	0.65	
3/8	BST-N3M	0.08	ST-N3M	0.07	SST-N3M	0.08	SSST-N3M*	0.08	3/8-18	1.69	0.86	0.69	0.79	
1/2	BST-N4M	0.15	ST-N4M	0.13	SST-N4M	0.13	-	-	1/2-14	1.94	1.01	0.88	1.01	
3/4	BST-N6M	0.23	ST-N6M	0.21	SST-N6M	0.22	-	-	3/4-14	2.19	1.11	1.06	1.23	
1	BST-N8M	0.46	ST-N8M	0.43	SST-N8M	0.43	-	-	1-11 1/2	2.51	1.34	1.38	1.59	

Contact division for BSPT port availability

* Fluorocarbon Seals are standard with 316 Stainless Steel

Replacement Parts

ST Series

ST Series O-Rings	1/8" Body Size	1/4" Size	3/8" Size	1/2" Size
Standard Nitrile*	2-010N0674-70	2-110N0674-70	2-112N0674-70	2-114N0674-70
ST Series O-Rings	3/4" Body Size	1" Size	1-1/4" Size	1-1/2" Size
Standard Nitrile*	2-212N0674-70	2-217N0674-70	2-221N0674-70	2-327N0674-70

* Other compounds available are Ethylene Propylene EO893-80, Fluorocarbon V0884-75, Neoprene C0557-70. To order change compound number. Example: BST-1Y (Fluorocarbon) = 2-010V0884-75. Consult Division for pricing.



Special Order Information

60 Series couplings are available in brass, 303 stainless steel, and 316 stainless steel. Brass couplings have double O-Ring seals and stainless locking balls.

Standard seal materials are Nitrile; optional seal materials are available.

For 316 stainless steel products, standard seal material is Fluorocarbon, and other seal materials are available upon request. See Fluid Compatibility Chart at end of this catalog.

All sizes of 60 Series can be furnished with locking sleeves. Place suffix letters "SL" (Sleeve-Lok) after regular catalog numbers. Example SH3-62SL.

Applications

Parker general purpose couplings, are used across the spectrum of hydraulic applications. These Double Shut-Off couplings can be found anywhere that fluid transfer lines need to be connected and disconnected for operation or maintenance of equipment, and a loss of fluid is undesirable. Primarily used with hydraulic fluid, general purpose Double Shut-Off couplings are also used with chemicals, water, steam, and some gases.

Note

Protective dust plugs and caps play a crucial role in the life of a quick coupling and no purchase of a hydraulic quick coupling is complete without the selection of an appropriate dust plug and cap. See pages noted in Table of Contents for dust plugs and caps for the Parker full line of hydraulic couplings.

Specifications

ANSI/ISO Pressure Rating: Dynamic applications with normal to moderate hydraulic shocks such as general industrial equipment, hydraulic presses, agricultural equipment, etc. Impulse tested at a multiple (125% to 133%) of rated pressure.									Low Cycle, Non-pulsating Pressure Rating: Applications with lower cycle life and no severe cyclic pressure fluctuations, essentially steady pressure during an operating cycle. Typical applications include hydraulic jacks, mine roof support systems, and high pressure fluid transfer (pumping water or slurry in oil wells). Minor pump ripple is considered non-pulsating. Impulse tested at rated pressure.									
Body Size	1/8	1/4	3/8	1/2	3/4	1	1 1/2	2 1/2	1/8	1/4	3/8	1/2	3/4	1	1 1/2	2 1/2		
	Rated Pressure (PSI)									Rated Pressure (PSI)								
Brass	1000	1000	1000	1000	1000	1000	800	800	3000	3700	2700	3500	2200	1500	1500	1200		
Stainless steel	2000	2000	1500	1500	1500	1000	1000	1000	5000	5000	5000	5000	3000	3000	1500	1500		
Temperature Range: Standard seals (Nitrile) -40° to +250° F Optional Fluorocarbon seals -15° to +400° F																		
Vacuum Data: 27.4 inches Hg, both connected and disconnected (1-1/2" and 2-1/2" body size 60 Series couplings not recommended for service in the disconnected mode)																		
Note: Read the Safety Guide for Selecting and Using Quick Action Couplings and Related Accessories before making a coupling selection. It may be found in Parker Hannifin Quick Coupling Division catalogs and is available as Parker Publication No. 3800-B1.0.																		

Body Size	1/8	1/4	3/8	1/2	3/4	1	1 1/2	2 1/2
Rated Flow (GPM)	.8	3	6	12	28	50	100	200

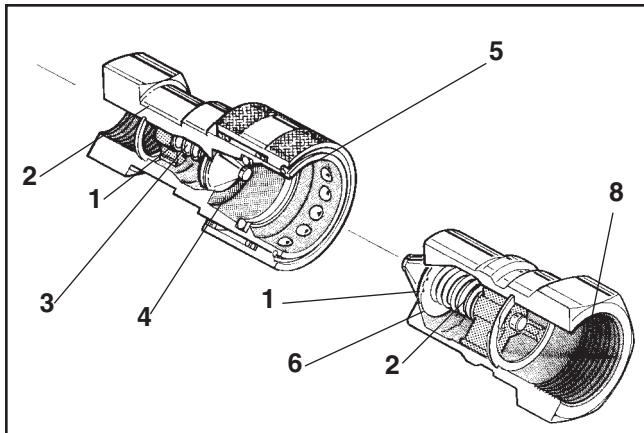

Features

1. Large flow areas machined into the body of the coupler and nipple facilitate flow around the valve, for a high flow capacity.
2. Positive valve stop. The perch maintains valve alignment and provides metal to metal valve stop to ensure that the valves open fully, every time.

3. Captive valve seal assures “bubble tight” poppet sealing. The valve seal is positively captured by the metal poppet to minimize seal washout or damage from high velocity fluid.
4. The seal is designed to withstand high pressures and provide reliable sealing. A wide selection of optional seal materials are available, see Fluid Compatibility Chart at end of this catalog for selection assistance. Stainless steel versions feature PTFE back-up rings that support mating seals for high pressure applications. Brass couplers have a double O-ring seal for redundancy in low pressure, vacuum and steam applications.
5. Durable ball-locking mechanism assures reliable connection, every time. A large number of locking balls distributes the work load evenly while providing alignment and swiveling action to reduce hose torque and prolong hose life.
6. Manufactured from brass, steel and stainless steel as standard materials. A wide range of seals allow these couplings to be used with a broad range of media.
7. Industry-wide interchangeability. Parker 60 Series couplers and nipples are the “Industrial Interchange” design and Interchange with all ISO 7241 Series B couplings.
8. Also available with a Straight Thread (ORB) end configuration available as standard, for reduced leakage.

Performance

60 Series (1/8" & 1/4")
Test Fluid: Oil - 150 SUS

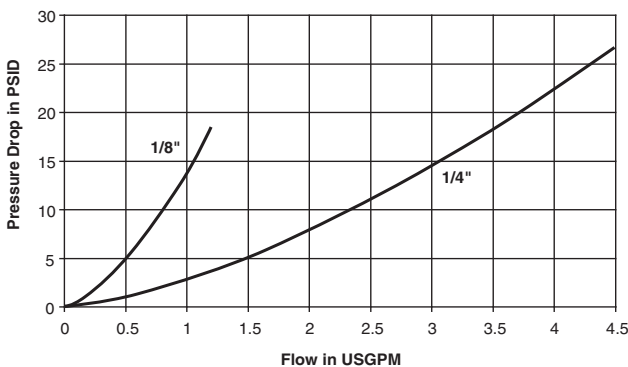

60 Series (3/8" & 1/2")
Test Fluid: Oil - 150 SUS

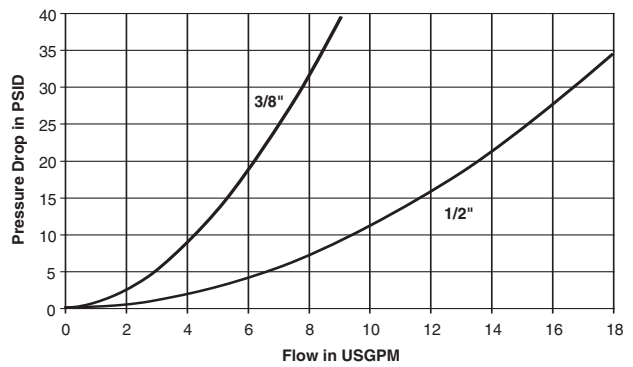

60 Series (3/4" & 1")
Test Fluid: Oil - 150 SUS

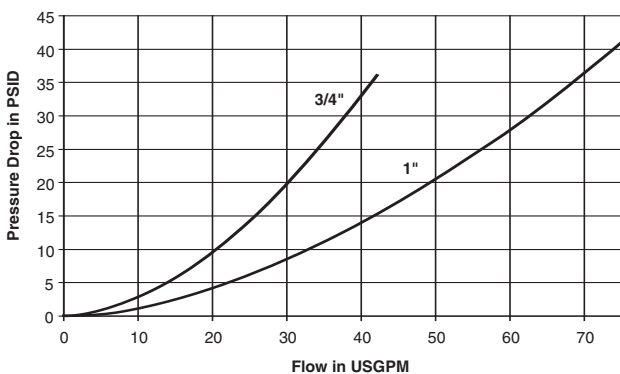

60 Series (1-1/2" & 2-1/2")
Test Fluid: Oil - 200 SUS

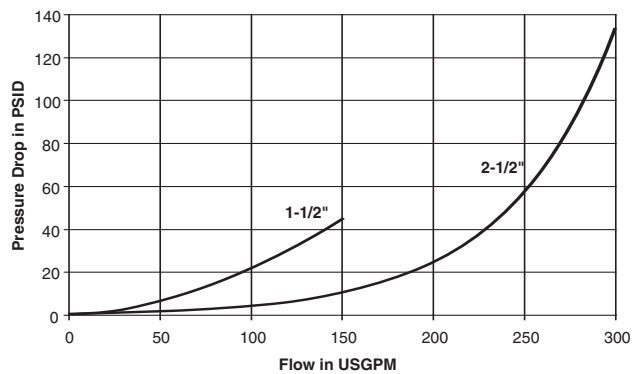

Quick Coupling Products

General Purpose Couplings 60 Series

Couplers

Female Thread

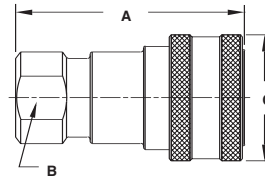

Body Size (in.)	Part No. Brass	Wt. (LB.) P/Piece	Part No. Type 303 Stainless	Wt. (LB.) P/Piece	Part No. Type 316 Stainless	Wt. (LB.) P/Piece	Thread Size NPTF	Thread Size ORB	Dimensions (in.)		
									Overall Length	Wrench Flats	Largest Diameter
									A	B	C
1/8	BH1-60	0.16	SH1-62	0.16	SSH1-62Y*	0.15	1/8-27	—	1.90	0.68	0.96
1/8	—	0.18	SH1-62-T4	0.10	SSH1-62Y-T4	0.17	—	7/16-20	2.06	0.68	0.96
1/4	BH2-60	0.32	SH2-62	0.30	SSH2-62Y	0.30	1/4-18	—	2.26	0.81	1.14
1/4	—	0.33	SH2-62-T6	0.31	SSH2-62Y-T6	0.31	—	9/16-18	2.41	0.81	1.14
3/8	BH3-60	0.43	SH3-62	0.40	SSH3-62Y	0.40	3/8-18	—	2.49	0.88	1.40
3/8	—	0.49	SH3-62-T8	0.51	SSH3-62Y-T8	0.51	—	3/4-16	2.75	1.00	1.40
1/2	BH4-60	0.80	SH4-62	0.75	SSH4-62Y	0.76	1/2-14	—	2.87	1.12	1.77
1/2	—	0.85	SH4-62-T10	0.75	SSH4-62Y-T10	0.78	—	7/8-14	3.05	1.12	1.77
3/4	BH6-60	1.39	SH6-62	1.31	SSH6-62Y	1.33	3/4-14	—	3.56	1.31	2.14
3/4	—	1.42	SH6-62-T12	1.34	SSH6-62Y-T12	1.40	—	1 1/16-12	3.56	1.31	2.14
1	BH8-60	1.95	SH8-62	1.95	SSH8-62Y	1.95	1-11 1/2	—	4.18	1.62	2.52
1	—	1.95	SH8-62-T16	1.95	SSH8-62Y-T16	1.95	—	1 5/16-12	4.18	1.62	2.52

Contact division for BSPP port availability

Nipples

Female Thread

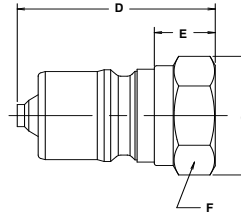

Body Size (in.)	Part No. Brass	Wt. (LB.) P/Piece	Part No. Type 303 Stainless	Wt. (LB.) P/Piece	Part No. Type 316 Stainless	Wt. (LB.) P/Piece	Thread Size NPTF	Thread Size ORB	Dimensions (in.)			
									Overall Length	Exposed Length	Wrench Flats	Largest Diameter
									D	E	F	G
1/8	BH1-61	0.04	SH1-63	0.03	SSH1-63Y*	0.04	1/8-27	—	1.26	0.41	0.56	0.65
1/8	—	0.06	SH1-63-T4	—	SSH1-63Y-T4	0.06	—	7/16-20	1.41	0.57	0.69	0.79
1/4	BH2-61	0.09	SH2-63	0.08	SSH2-63Y	0.08	1/4-18	—	1.54	0.65	0.75	0.87
1/4	—	0.11	SH2-63-T6	0.10	SSH2-63Y-T6	0.10	—	9/16-18	1.69	0.70	0.88	1.01
3/8	BH3-61	0.10	SH3-63	0.12	SSH3-63Y	0.12	3/8-18	—	1.68	0.54	0.88	1.01
3/8	—	0.12	SH3-63-T8	0.16	SSH3-63Y-T8	0.14	—	3/4-16	1.94	0.80	1.00	1.15
1/2	BH4-61	0.25	SH4-63	0.24	SSH4-63Y	0.24	1/2-14	—	1.94	0.69	1.12	1.30
1/2	—	0.28	SH4-63-T10	0.27	SSH4-63Y-T10	0.27	—	7/8-14	2.12	0.87	1.19	1.37
3/4	BH6-61	0.50	SH6-63	0.45	SSH6-63Y	0.46	3/4-14	—	2.43	0.79	1.38	1.59
3/4	—	0.55	SH6-63-T12	0.50	SSH6-63Y-T12	0.50	—	1 1/16-12	2.54	0.90	1.34	1.59
1	BH8-61	0.76	SH8-63	0.76	SSH8-63Y	0.76	1-1 1/2	—	2.91	0.99	1.62	1.88
1	—	0.80	SH8-63-T16	0.80	SSH8-63Y-T16	0.80	—	1 5/16-12	2.91	0.99	1.62	1.88

* Suffix 'Y' designates Fluorocarbon Seal. (Contact factory for seal options)

Contact division for BSPP port availability

Dust Protectors

60 Series



Body Size (in.)	Dust Plug Part No. Aluminum	Dust Plug Part No. Geolast	Dust Cap Part No. Aluminum	Dust Cap Part No. Geolast
1/8	H1-65	H1-65M	H1-66	H1-66M
1/4	H2-65	H2-65M	H2-66	H2-66M
3/8	H3-65	H3-65M	H3-66	H3-66M
1/2	H4-65	H4-65M	H4-66	H4-66M
3/4	H6-65	H6-65M	H6-66	H6-66M
1	H8-65	H8-65M	H8-66	H8-66M
1 1/2	H12-65	NA	H12-66	NA

NA = Not Available



Quick Coupling Products

General Purpose Couplings 60 Series

Couplers

Female Thread

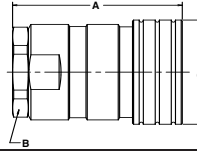

Body Size (in.)	Part No. Brass	Wt. (LB.) P/Piece	Part No. Type 303 Stainless	Wt. (LB.) P/Piece	Part No. Type 316 Stainless	Wt. (LB.) P/Piece	Thread Size NPTF	Thread Size ORB	Dimensions (in.)		
									Overall Length	Wrench Flats	Largest Diameter
									A	B	C
1 1/2	BH12-60L	4.58	SH12-62L	4.68	SSH12-62LY*	4.68	1 1/4-11 1/2	–	4.86	2.38 [‡]	3.00
1 1/2	BH12-60N	4.58	SH12-62N	4.68	SSH12-62NY	4.68	1 1/2-11 1/2	–	4.86	2.38 [‡]	3.00
1 1/2	–	4.61	SH12-62-T20	4.71	SSH12-62Y-T20	4.71	–	1 5/8-12	4.86	2.38 [‡]	3.00
1 1/2	–	4.61	SH12-62-T24	4.71	SSH12-62Y-T24	4.71	–	1 7/8-12	4.86	2.38 [‡]	3.00
2 1/2	BH2016-60	11.06	SH2016-62	–	SSH2016-62Y	–	2-11 1/2	–	5.57	3.75	4.10
2 1/2	BH2020-60	11.42	SH2020-62	–	SSH2020-62Y	–	2 1/2-8	–	6.04	3.75	4.10
2 1/2	BH2024-60	–	SH2024-62	–	SSH2024-62Y	–	3-8	–	6.96	4.00	4.35

* Suffix 'Y' designates Fluorocarbon Seal. (Consult factory for seal options)

‡Wrench Flat on 303 Stainless is 2.50 in.

Contact division for BSPP port availability

Nipples

Female Thread

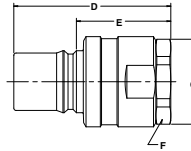

Body Size (in.)	Part No. Brass	Wt. (LB.) P/Piece	Part No. Type 303 Stainless	Wt. (LB.) P/Piece	Part No. Type 316 Stainless	Wt. (LB.) P/Piece	Thread Size NPTF	Thread Size ORB	Dimensions (in.)			
									Overall Length	Exposed Length	Wrench Flats	Largest Diameter
									D	E	F	G
1 1/2	BH12-61L	2.96	SH12-63L	3.06	SSH12-63LY*	–	1 1/4-11 1/2	–	4.76	2.69	2.38 [‡]	2.75**
1 1/2	BH12-61N	2.96	SH12-63N	3.06	SSH12-63NY	–	1 1/2-11 1/2	–	4.76	2.69	2.38 [‡]	2.75**
1 1/2	–	–	SH12-63-T20	3.14	SSH12-63Y-T20	–	–	1 5/8-12	4.76	2.69	2.38 [‡]	2.75**
1 1/2	–	–	SH12-63-T24	3.14	SSH12-63Y-T24	–	–	1 7/8-12	4.76	2.69	2.38 [‡]	2.75**
2 1/2	BH2016-61	7.78	SH2016-63	7.92	SSH2016-63Y	–	2-11 1/2	–	5.48	2.90	3.75	4.10
2 1/2	BH2020-61	8.12	SH2020-63	8.16	SSH2020-63Y	–	2 1/2-8	–	5.95	3.37	3.75	4.10
2 1/2	BH2024-61	–	SH2024-63	–	SSH2024-63Y	–	3-8	–	6.87	4.29	4.00	4.35

* Suffix 'Y' designates Fluorocarbon Seal. (Consult factory for seal options)

** Largest diameter on Brass is 2.96" across Hex Corners

‡Hex on 303 Stainless is 2.50 in.

Contact division for BSPP port availability

Optional Seals

60 Series



Optional Seals Suffix*

W	Ethylene Propylene (EPR)
Y	Standard Fluorocarbon Seals
Z	Neoprene
-264	Perfluoroelastomer

Repair Kits

3/4" & 1" 60 Series

Couplers

Repair Kit Part No.	Used For Part No.
BH67G-60K	BH6-60
SH67G-62K	SH6-62
BH67J-60K	BH8-60
SH67J-62K	SH8-62

Nipples

Repair Kit Part No.	Used For Part No.
BH67G-61K	BH6-61
SH67G-63K	SH6-63
BH67J-61K	BH8-61
SH67J-63K	SH8-63

Thermoplastic Quick Couplings

	Valving	Coupler Style	Body Size (in.)	Material	Locking Mechanism	Std. Seal Material	Temp Range**	Rate Pressure
PF Series Chemical Transfer	Flush Face Non-Spill	Push-To-Connect	1/2", 1" and 2"	Polypropylene/ Stainless	Pawl lock	Fluorocarbon	+40° to +140° F	30 to 100 PSI
Spectrum™ Series	Valved or Unvalved	Push-To-Connect	1/8" & 3/8"	Acetal 316 SS	Finger Lock	Nitrile	0°F to 180°F	0 to 145 PSI
Spectrum™ Series	Valved or Unvalved	Push-To-Connect	1/8" & 3/8"	PVDF/SS 316 SS	Finger Lock	Fluorocarbon	0°F to 250°F	0 to 115 PSI
Spectrum™ Series	Valved or Unvalved	Push-To-Connect	3/8"	PVDF/ PEEK™	Finger Lock	Fluorocarbon	0°F to 250°F	15 - 115 PSI



Applications

- Chemical Dispensing Systems
- Spray Application Equipment
- Mini Bulk Tanks
- Replacement for Banjo Style Camlok Fittings & Ball Valves
- Bulk Transfer Barrels

Specifications

Body Size	1/2"	1"	2"
Materials:	Polypropylene		
Body	Polypropylene		
Springs	316 Stainless Steel		
Seals	Fluorocarbon ⁽¹⁾		
Rated Pressure (at 68° F)	100 PSI	60 PSI	100 PSI
Rated Flow	12 GPM	20 GPM	50 GPM
Pressure Drop at Rated Flow	11.3 PSI	3.4 PSI	4 PSI
Force to Connect	32 lbs.	54 lbs.	41 lbs.
Force to Disconnect	12 lbs.	17 lbs.	17 lbs.
Operating Temp.	+40°F to +140° F		
Storage Temp.	-20°F to +140° F		
Maximum Spillage per Disconnect	0.14 ml .01 cu. in.	1ml .06 cu. in. (1cc)	9 ml .5 cu. in.
Vacuum Rating	27.4 Hg	Contact Factory	Contact Factory

(1) Also available in EPDM, Nitrile, Neoprene, Perfluoroelastomer

Features

The Parker PF Series Dry Disconnect couplings virtually eliminate fluid loss upon disconnection and are designed to help meet the demand for closed system transfer and dispensing of chemicals and fluids with minimal environmental contamination. They can be used with concentrated or diluted industrial chemicals, fertilizers, herbicides, insecticides, fungicides or pesticides when transferring from bulk storage tanks, returnable containers, applicators, etc.

The PF Series 2" body size is ideal for large bulk transfer of fluids and eliminating fluid spillage when connecting and disconnecting.

Additional features include:

- Rugged Glass filled Polypropylene construction for chemical compatibility and reduced cost.
- Push-to-connect design.
- Flush face valves exhibit minimal spillage upon connect or disconnect and air inclusion on connect, and enables ease of cleaning.
- PTFE coated Fluorocarbon tank gasket for improved chemical compatibility.
- 1" coupler has non-wetted springs. Spring options available for nipples include: hastelloy springs designated -640, or kynar coated springs designated -714 .

Performance

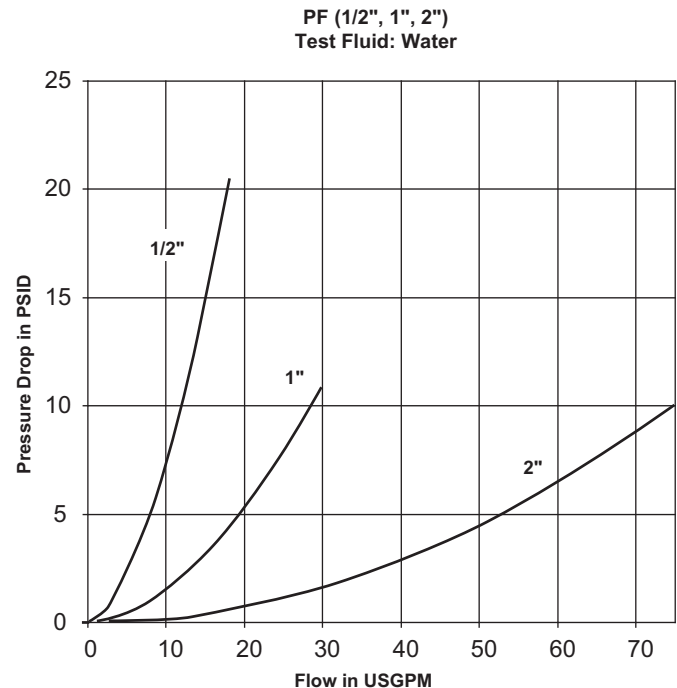

Quick Coupling Products

Thermoplastic Couplings PF Series

Couplers

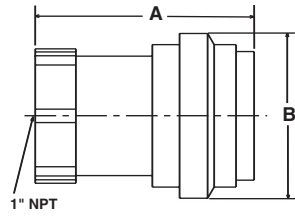

Body Size (in.)	Part No.	Port* Thread	Overall Length	Largest Diameter	Wrench Wt. (LB.) Flats	P/Piece
			A	B		
1/2	PF-501-8FP	1/2"NPT	3.02	1.88	1.38	0.18
1	PF-1001-16FP	1" NPT	3.99	3.00	1.99	0.53
2	PF-2001-32FP	2" NPT	6.63	5.00	-	1.75

* Female NPT Threads standard. For other port options contact the division.

Nipples

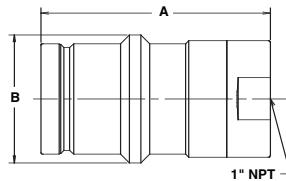

Body Size (in.)	Part No.	Port* Thread	Tank Mount Thread	Overall Length	Largest Diameter	Wrench Wt. (LB.) Flats	P/Piece
				A	B		
1/2	PF-502-8FP	1/2" NPT	None	2.96	1.33	1.24	0.09
1	PF-1002-16FP	1" NPT	None	3.92	2.20	1.87	0.26
2	PF-2002-32FP	2" NPT	None	5.71	3.55	-	0.75

* Female NPT Threads standard. For other port options contact the division.

Nipples - Tank Mount

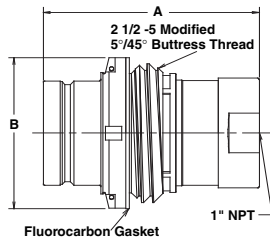

Body Size (in.)	Part No.	Port* Thread	Tank Mount Thread	Overall Length	Largest Diameter	Wrench Wt. (LB.) Flats	P/Piece
				A	B		
1	PF-1002-32MB	1" NPT	Modified Buttress	3.92	2.75	1.87	0.33
1	PF-1002-32MP	1" NPT	Modified NPS	3.92	2.75	1.87	0.31

* Female NPT Threads standard. For other port options contact the division.

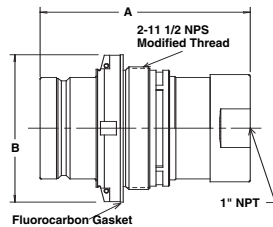

Dust Caps and Plugs

Coupler Dust Cap
FR-501



Nipple Dust Cap
FR-502

Nipple Dust Cap
PFR-1002



Nipple Dust Cap (Tank Mount)
PFR-1002-NS



Body Size (in.)	Coupler Dust Cap Part No.	Nipple Dust Cap Part No.	Material
1/2	FR-501	FR-502	Synthetic Rubber
1	None	PFR-1002	Ethylene Propylene
1	None	PFR-1002-NS*	Ethylene Propylene

* For use with Tank Mount Nipples



Description

Parker's Spectrum™ Series couplers are the most advanced engineered thermoplastic couplings available. Spectrum Series couplings combine compact size, high flow capability, and light weight design to meet a broad range of coupling applications. Three material combinations allow the couplings to be used in markets as diverse as chemical processing, automation equipment, semi-conductor and food processing. Spectrum Series can be used in many applications previously reserved for stainless steel couplings. Additional features include: convenient push-to-connect design, a wide range of port options, and modular design.

Features

- Excellent Chemical Compatibility
- Three Material Combinations: Acetal/SS, PVDF/SS and PVDF/PEEK™
- High Flow Capacity
- Easy Push-To-Connect Operation
- Available Valved and Unvalved
- Flexible Modular Design
- Four Point 360° Locking Mechanism
- Temperatures Up To 250° F
- Panel Mounting Option

Performance

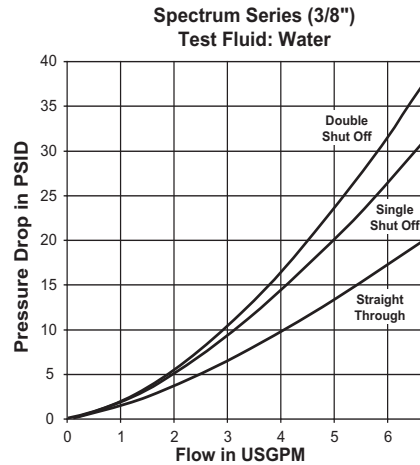
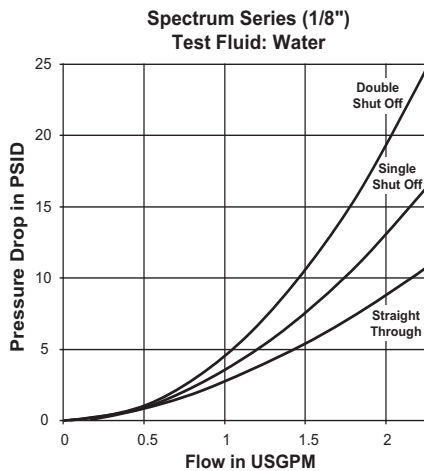

How To Order

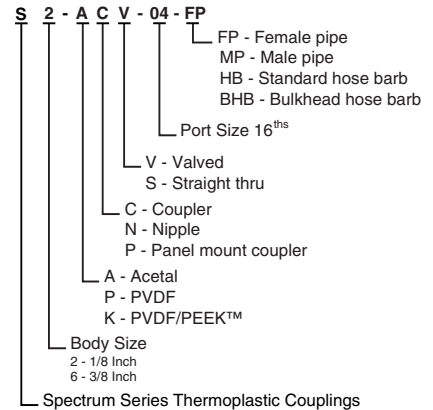

Specifications

	Acetal/SS (black with grey sleeve)		PVDF/SS (translucent with green sleeve)		PVDF/PEEK™ (translucent)
	1/8	3/8	1/8	3/8	3/8
Range Pressure	0-145 psi (0-10 bar)	0-145 psi (0-10 bar)	0-115 psi (0-8 bar)	0-115 psi (0-8 bar)	15-115 psi (1-8 bar)
Temperature Range	0° F to 180° F (-20° C to +80° C)	0° F to 180° F (-20° C to +80° C)	0° F to 250° F (-20° C to +120° C)	0° F to 250° F (-20° C to +120° C)	0° F to 250° F (-20° C to +120° C)
Rated Flow (DSO)	1.5 GPM (5.6 lpm)	4.5 GPM (17 lpm)	1.5 GPM (5.6 lpm)	4.5 GPM (17 lpm)	4.5 GPM (17 lpm)
Body Material	Acetal	Acetal	PVDF	PVDF	PVDF
Spring Material	316 SS	316 SS	316 SS	316 SS	PEEK
Seal Material	Nitrile	Nitrile	Fluorocarbon	Fluorocarbon	Fluorocarbon

Couplers

Female Pipe

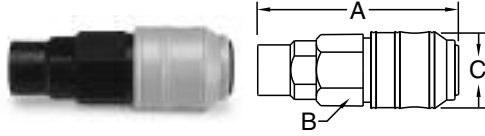

Body Size (in.)	Acetal Part No.	PVDF Part No.	PVDF/PEEK™ Part No.	Port NPT	Overall Length	Hex Size	Largest Diameter
					A	B	C
1/8	S2-AC*-02-FP	S2-PC*-02-FP	—	1/8-27	2.15	.67	.82
1/8	S2-AC*-04-FP	S2-PC*-04-FP	—	1/4-18	2.34	.67	.82
3/8	S6-AC*-04-FP	S6-PC*-04-FP	S6-KC*-04-FP	1/4-18	2.63	.82	1.02
3/8	S6-AC*-06-FP	S6-PC*-06-FP	S6-KC*-06-FP	3/8-18	2.63	.82	1.02
3/8	S6-AC*-08-FP	S6-PC*-08-FP	S6-KC*-08-FP	1/2-14	3.10	.82	1.02

Male Pipe

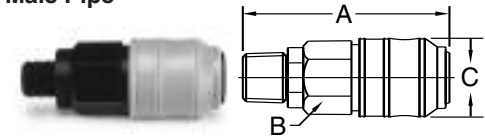

Body Size (in.)	Acetal Part No.	PVDF Part No.	PVDF/PEEK™ Part No.	Port NPT	Overall Length	Hex Size	Largest Diameter
					A	B	C
1/8	S2-AC*-02-MP	S2-PC*-02-MP	—	1/8-27	2.04	.67	.82
1/8	S2-AC*-04-MP	S2-PC*-04-MP	—	1/4-18	2.15	.67	.82
3/8	S6-AC*-04-MP	S6-PC*-04-MP	S6-KC*-04-MP	1/4-18	2.90	.82	1.02
3/8	S6-AC*-06-MP	S6-PC*-06-MP	S6-KC*-06-MP	3/8-18	2.77	.82	1.02
3/8	S6-AC*-08-MP	S6-PC*-08-MP	S6-KC*-08-MP	1/2-14	3.10	.82	1.02

Hose Barb

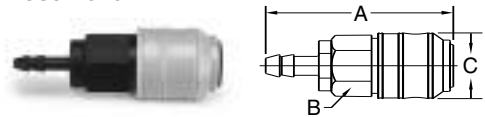

Body Size (in.)	Acetal Part No.	PVDF Part No.	PVDF/PEEK™ Part No.	Hose I.D.	Overall Length	Hex Size	Largest Diameter
					A	B	C
1/8	S2-AC*-03-HB	S2-PC*-03-HB	—	3/16 (4 mm)	2.34	.67	.82
1/8	S2-AC*-04-HB	S2-PC*-04-HB	—	1/4 (6 mm)	2.34	.67	.82
3/8	S6-AC*-04-HB	S6-PC*-04-HB	S6-KC*-04-HB	1/4 (6 mm)	3.19	.82	1.02
3/8	S6-AC*-06-HB	S6-PC*-06-HB	S6-KC*-06-HB	3/8 (9 mm)	3.19	.82	1.02
3/8	S6-AC*-08-HB	S6-PC*-08-HB	S6-KC*-08-HB	1/2 (13 mm)	3.31	.82	1.02

Bulkhead Hose Barb

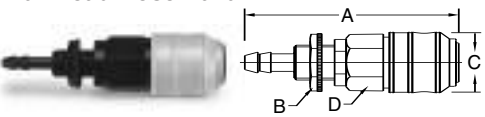

Body Size (in.)	Acetal Part No.	PVDF Part No.	PVDF/PEEK™ Part No.	Hose I.D.	Overall Length	Hex Size	Largest Diameter	Bulkhead Hex
					A	B	C	D
1/8	S2-AC*-03-BHB	S2-PC*-03-BHB	—	3/16 (4 mm)	2.89	.67	.82	.67
1/8	S2-AC*-04-BHB	S2-PC*-04-BHB	—	1/4 (6 mm)	2.89	.67	.82	.67

Panel Mount Couplers

Female Pipe

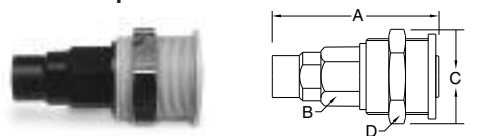

Body Size (in.)	Acetal Part No.	PVDF Part No.	PVDF/PEEK™ Part No.	Hose I.D.	Overall Length	Hex Size	Largest Diameter	Bulkhead Hex
					A	B	C	D
1/8	S2-AP*-02-FP	S2-PP*-02-FP	—	1/8-27	2.04	.67	1.10	1.06
1/8	S2-AP*-04-FP	S2-PP*-04-FP	—	1/4-18	2.16	.67	1.10	1.06

Hose Barb

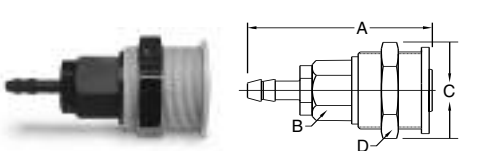

Body Size (in.)	Acetal Part No.	PVDF Part No.	PVDF/PEEK™ Part No.	Hose I.D.	Overall Length	Hex Size	Largest Diameter	Bulkhead Hex
					A	B	C	D
1/8	S2-AP*-03-HB	S2-PP*-03-HB	—	3/16 (4 mm)	2.34	.67	1.10	1.06
1/8	S2-AP*-04-HB	S2-PP*-04-HB	—	1/4 (6 mm)	2.34	.67	1.10	1.06

* NOTE: Replace * with "V" for Valved version and "S" for Non-Valved version

Valved Nipples

Female Pipe

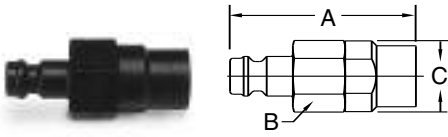

Body Size (in.)	Acetal Part No.	PVDF Part No.	PVDF/PEEK™ Part No.	Port NPT	Overall Length	Hex Size	Largest Diameter
					A	B	C
1/8	S2-ANV-02-FP	S2-PNV-02-FP	—	1/8-27	1.61	.67	.76
1/8	S2-ANV-04-FP	S2-PNV-04-FP	—	1/4-18	1.80	.67	.76
3/8	S6-ANV-04-FP	S6-PNV-04-FP	S6-KNV-04-FP	1/4-18	2.02	.83	.91
3/8	S6-ANV-06-FP	S6-PNV-06-FP	S6-KNV-06-FP	3/8-18	2.02	.83	.91
3/8	S6-ANV-08-FP	S6-PNV-08-FP	S6-KNV-08-FP	1/2-14	2.49	.83	.91

Male Pipe

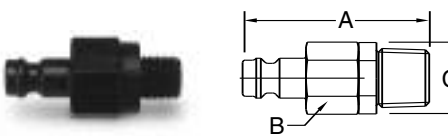

Body Size (in.)	Acetal Part No.	PVDF Part No.	PVDF/PEEK™ Part No.	Port NPT	Overall Length	Hex Size	Largest Diameter
					A	B	C
1/8	S2-ANV-03-MP	S2-PNV-03-MP	—	1/8-27	1.49	.67	.76
1/8	S2-ANV-04-MP	S2-PNV-04-MP	—	1/4-18	1.80	.67	.76
3/8	S6-ANV-04-MP	S6-PNV-04-MP	S6-KNV-04-MP	1/4-18	2.24	.83	.91
3/8	S6-ANV-06-MP	S6-PNV-06-MP	S6-KNV-06-MP	3/8-18	2.16	.83	.91
3/8	S6-ANV-08-MP	S6-PNV-08-MP	S6-KNV-08-MP	1/2-14	2.49	.83	.91

Hose Barb

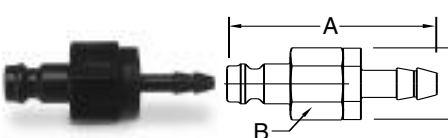

Body Size (in.)	Acetal Part No.	PVDF Part No.	PVDF/PEEK™ Part No.	Hose I.D.	Overall Length	Hex Size	Largest Diameter
					A	B	C
1/8	S2-ANV-03-HB	S2-PNV-03-HB	—	3/16 (4 mm)	1.80	.67	.76
1/8	S2-ANV-04-HB	S2-PNV-04-HB	—	1/4 (6 mm)	1.80	.67	.76
3/8	S6-ANV-04-HB	S6-PNV-04-HB	S6-KNV-04-HB	1/4 (6 mm)	2.59	.82	.91
3/8	S6-ANV-06-HB	S6-PNV-06-HB	S6-KNV-06-HB	3/8 (9 mm)	2.59	.82	.91
3/8	S6-ANV-08-HB	S6-PNV-08-HB	S6-KNV-08-HB	1/2 (13 mm)	2.71	.82	.91

Bulkhead Hose Barb

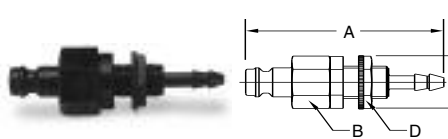

Body Size (in.)	Acetal Part No.	PVDF Part No.	PVDF/PEEK™ Part No.	Hose I.D.	Overall Length	Hex Size	Largest Diameter	Bulkhead Hex
					A	B	C	D
1/8	S2-ANV-03-BHB	S2-PNV-03-BHB	—	3/16 (4 mm)	2.35	.67	.76	.55
1/8	S2-ANV-04-BHB	S2-PNV-04-BHB	—	1/4 (6 mm)	2.35	.67	.76	.55

Nipples

Female Pipe

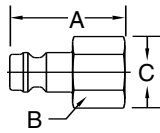

Body Size (in.)	Acetal Part No.	PVDF Part No.	PVDF/PEEK™ Part No.	Port NPT	Overall Length	Hex Size	Largest Diameter
					A	B	C
1/8	S2-ANS-02-FP	S2-PNS-02-FP	—	1/8-27	1.02	.55	.62
1/8	S2-ANS-04-FP	S2-PNS-04-FP	—	1/4-18	1.18	.67	.76
3/8	S6-ANS-04-FP	S6-PNS-04-FP	—	1/4-18	1.52	.67	.73
3/8	S6-ANS-06-FP	S6-PNS-06-FP	—	3/8-18	1.52	.83	.91
3/8	S6-ANS-08-FP	S6-PNS-08-FP	—	1/2-14	1.68	.98	1.09

Male Pipe

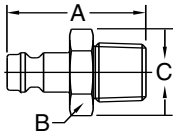

Body Size (in.)	Acetal Part No.	PVDF Part No.	PVDF/PEEK™ Part No.	Port NPT	Overall Length	Hex Size	Largest Diameter
					A	B	C
1/8	S2-ANS-02-MP	S2-PNS-02-MP	—	1/8-27	1.08	.55	.62
1/8	S2-ANS-04-MP	S2-PNS-04-MP	—	1/4-18	1.24	.67	.76
3/8	S6-ANS-04-MP	S6-PNS-04-MP	—	1/4-18	1.64	.67	.73
3/8	S6-ANS-06-MP	S6-PNS-06-MP	—	3/8-18	1.64	.83	.91
3/8	S6-ANS-08-MP	S6-PNS-08-MP	—	1/2-14	1.83	.94	1.04

Hose Barb

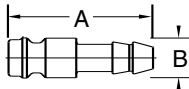

Body Size (in.)	Acetal Part No.	PVDF Part No.	PVDF/PEEK™ Part No.	Hose I.D.	Overall Length	Largest Diameter
					A	B
1/8	S2-ANS-03-HB	S2-PNS-03-HB	—	3/16 (4 mm)	1.26	.34
1/8	S2-ANS-04-HB	S2-PNS-04-HB	—	1/4 (6 mm)	1.26	.34
3/8	S6-ANS-04-HB	S6-PNS-04-HB	—	1/4 (6 mm)	1.86	.71
3/8	S6-ANS-06-HB	S6-PNS-06-HB	—	3/8 (9 mm)	1.87	.71
3/8	S6-ANS-08-HB	S6-PNS-08-HB	—	1/2 (13 mm)	1.99	.71

Bulkhead Hose Barb

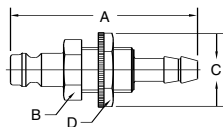

Body Size (in.)	Acetal Part No.	PVDF Part No.	PVDF/PEEK™ Part No.	Hose I.D.	Overall Length	Hex Size	Largest Diameter	Bulkhead Hex
					A	B	C	D
1/8	S2-ANS-03-BHB	S2-PNS-03-BHB	—	3/16 (4 mm)	1.97	.55	.64	.55
1/8	S2-ANS-04-BHB	S2-PNS-04-BHB	—	1/4 (6 mm)	1.97	.55	.77	.67

Pneumatic Quick Couplings

Quick Coupling Products

Pneumatic Quick Couplings Coupling Selection Guide

	Coupler Style	Interchange	Body Size (in.)	Material*			Locking Mechanism	Std. Seal Material	Temp Range**	Rated Pressure
				Br	SS	S				
HF Series***	Push-To-Connect	Industrial	1/8" to 1/2"	•	•		Ball	Nitrile	-40° to +250° F	300 PSI
DM Series	Push-To-Connect Double Shut-Off	DM	1/8"	•			Ball	Fluorocarbon	-15° to +400° F	250 PSI

* See Fluid Compatibility chart and/or consult factory for questions regarding proper material for specific applications.

CODE: Br = Brass; SS = Stainless Steel; S = Steel; P = Plastic

**Temperature Range for standard seal material.

***HF Series 1/8" couplings have no standard industry interface and require the HF Series 1/8" Nipple.



Features

- Parker HF Series Pneumatic Quick Couplings offer an alternative to traditional industrial interchange couplers. The quality and durability you have come to expect from Parker 20 Series couplers, combined with a slim profile, push-to-connect design. The result is an easy to use general purpose pneumatic coupler suitable for use in a variety of applications.
- Parker HF couplers feature sleeve guards to protect against accidental disconnection.**
- Standard couplers feature solid brass construction, high flow valving, corrosion resistant valves, and stainless steel locking balls and valve spring.
- Parker HF couplers accept Industrial Interchange nipples* manufactured by Parker and other manufacturers. See table of contents.

* 1/8" couplings have no standard industry interface.

** 1/8" couplings do not incorporate an integral sleeve guard.

How To Order

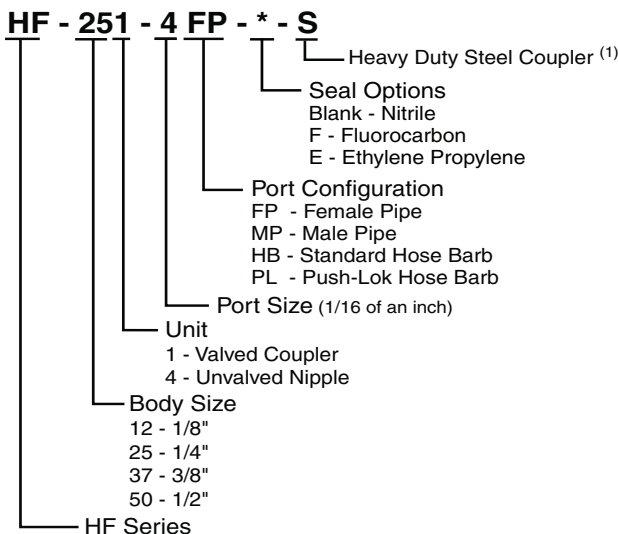

(1) 1/8" and 1/2" are not available in a heavy duty version.

Specifications

Body Size (in.)	1/8	1/4	3/8	1/2
Rated Pressure (psi)	250	300	300	300
Temperature Range (Std. seals)	-40° to +250°F			
Locking Device	5 balls	4 balls	6 balls	8 balls
Vacuum Data (inches Hg)				
Disconnected (coupler only)	Not Recommended			
Connected	—	27.4	27.4	27.4

Performance

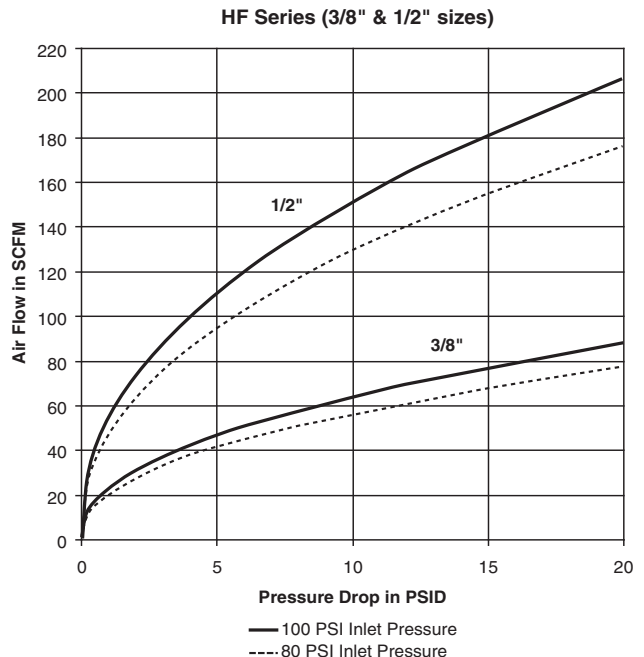
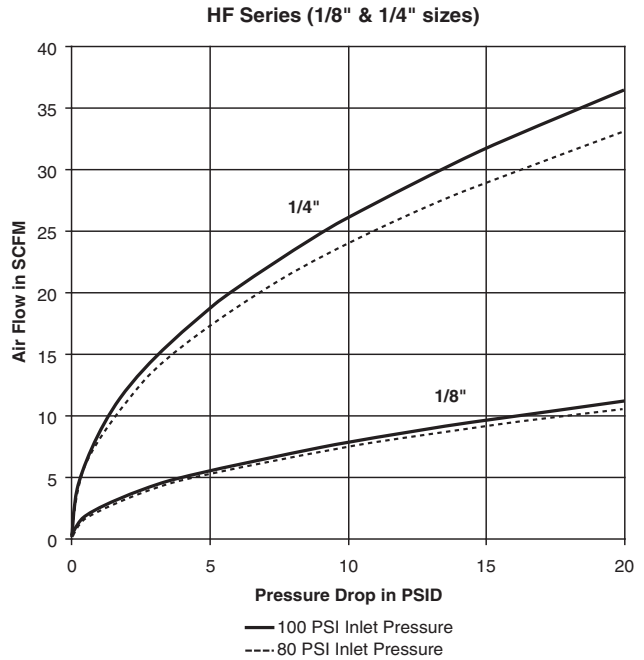

Quick Coupling Products

Pneumatic Couplings – Push-To-Connect HF Series

1/8" Body Size Couplers

Female Pipe Thread

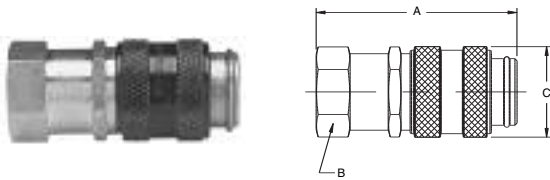

Body Size (in.)	Part No. Brass	Thread Size NPTF	Dimensions (in.)			Wt. (LB) P/Piece
			Overall Length	Hex Size	Largest Diameter	
			A	B	C	
1/8	HF-121-2FP	1/8-27	1.42	0.55	0.63	0.06
1/8	HF-121-4FP	1/4-18	1.81	0.67	0.63	0.10

Male Pipe Thread

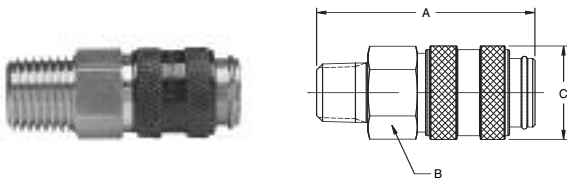

Body Size (in.)	Part No. Brass	Thread Size NPTF	Dimensions (in.)			Wt. (LB) P/Piece
			Overall Length	Hex Size	Largest Diameter	
			A	B	C	
1/8	HF-121-2MP	1/8-27	1.50	0.55	0.63	0.06
1/8	HF-121-4MP	1/4-18	1.61	0.55	0.63	0.07

1/8" Body Size Nipples

Female Pipe Thread

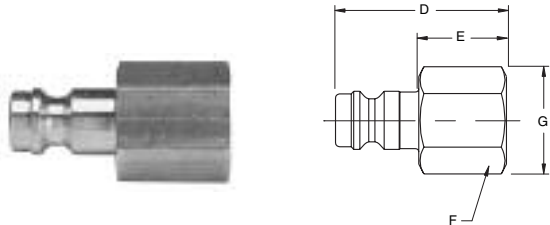

Body Size (in.)	Part No. Brass	Thread Size NPTF	Dimensions (in.)				Wt. (LB) P/Piece
			Overall Length	Exposed Length*	Hex Size	Largest Diameter	
			D	E	F	G	
1/8	HF-124-2FP	1/8-27	1.08	0.55	0.50	0.58	0.03
1/8	HF-124-4FP	1/4-18	1.34	0.81	0.67	0.78	0.07

* This dimension represents the portion that is exposed when nipple is inserted in a Parker HF series coupler.

Male Pipe Thread

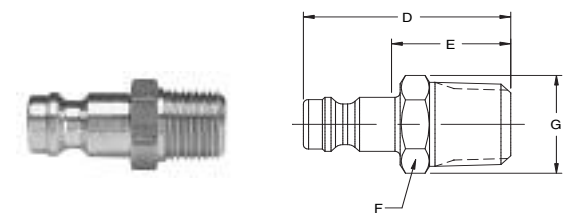

Body Size (in.)	Part No. Brass	Thread Size NPTF	Dimensions (in.)				Wt. (LB) P/Piece
			Overall Length	Exposed Length*	Hex Size	Largest Diameter	
			D	E	F	G	
1/8	HF-124-2MP	1/8-27	1.06	0.53	0.44	0.51	0.03
1/8	HF-124-4MP	1/4-18	1.25	0.72	0.56	0.63	0.05

* This dimension represents the portion that is exposed when nipple is inserted in a Parker HF series coupler.

Quick Coupling Products

1/4" and 3/8" Body Size Couplers

Female Pipe Thread

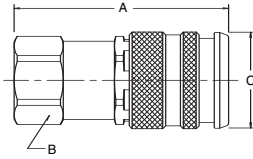

Body Size (in.)	Part No. Brass	Thread Size NPSF	Dimensions (in.)			Wt. (LB) P/Piece
			Overall Length	Hex Size	Largest Diameter	
			A	B	C	
1/4	HF-251-4FP	1/4-18	2.19	0.81	0.99	0.26
1/4	HF-251-6FP	3/8-18	2.34	0.81	0.99	0.27
3/8	HF-371-4FP	1/4-18	2.33	0.94	1.07	0.33
3/8	HF-371-6FP	3/8-18	2.33	0.94	1.07	0.31
3/8	HF-371-8FP	1/2-14	2.49	1.00	1.07	0.35
1/2	HF-501-8FP	1/2-14	3.35	1.06	1.19	0.60

Male Pipe Thread

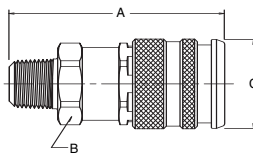

Body Size (in.)	Part No. Brass	Thread Size NPTF	Dimensions (in.)			Wt. (LB) P/Piece
			Overall Length	Hex Size	Largest Diameter	
			A	B	C	
1/4	HF-251-4MP	1/4-18	2.34	0.81	0.99	0.25
1/4	HF-251-6MP	3/8-18	2.37	0.81	0.99	0.26
3/8	HF-371-4MP	1/4-18	2.49	0.94	1.07	0.32
3/8	HF-371-6MP	3/8-18	2.52	0.94	1.07	0.30
3/8	HF-371-8MP	1/2-14	2.68	0.94	1.07	0.33
1/2	HF-501-8MP	1/2-14	3.48	1.06	1.19	0.57

Standard Hose Barb

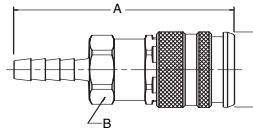

Body Size (in.)	Part No. Brass	Hose I.D.	Dimensions (in.)			Wt. (LB) P/Piece
			Overall Length	Hex Size	Largest Diameter	
			A	B	C	
1/4	HF-251-4HB	1/4	2.81	0.81	0.99	0.26
1/4	HF-251-6HB	3/8	2.81	0.81	0.99	0.27
3/8	HF-371-6HB	3/8	3.02	0.94	1.07	0.31
3/8	HF-371-8HB	1/2	3.02	0.94	1.07	0.34

Push-Lok Hose Barb

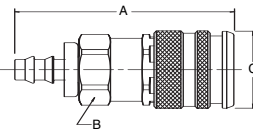

Body Size (in.)	Part No. Brass	Hose I.D.	Dimensions (in.)			Wt. (LB) P/Piece
			Overall Length	Hex Size	Largest Diameter	
			A	B	C	
1/4	HF-251-4PL	1/4	2.64	0.81	0.99	0.26
1/4	HF-251-6PL	3/8	2.78	0.81	0.99	0.27
3/8	HF-371-6PL	3/8	3.02	0.94	1.07	0.33
3/8	HF-371-8PL	1/2	3.07	0.94	1.07	0.31

Quick Coupling Products

Heavy Duty Couplers

Female Pipe Thread

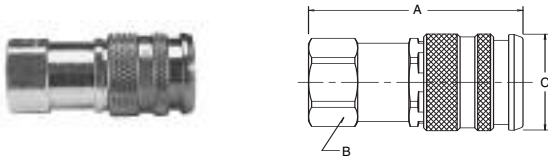

Body Size (in.)	Part No. Steel	Thread Size NPSF	Dimensions (in.)			Wt. (LB) P/Piece
			Overall Length	Hex Size	Largest Diameter	
			A	B	C	
1/4	HF-251-4FP-S	1/4-18	2.19	0.81	0.99	0.26
1/4	HF-251-6FP-S	3/8-18	2.34	0.81	0.99	0.27
3/8	HF-371-4FP-S	1/4-18	2.33	0.94	1.07	0.33
3/8	HF-371-6FP-S	3/8-18	2.33	0.94	1.07	0.31
3/8	HF-371-8FP-S	1/2-14	2.49	1.00	1.07	0.35

Male Pipe Thread

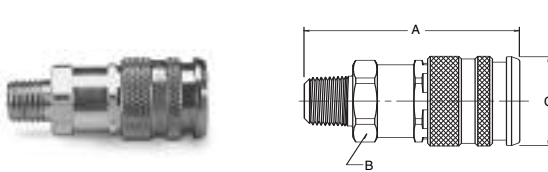

Body Size (in.)	Part No. Steel	Thread Size NPTF	Dimensions (in.)			Wt. (LB) P/Piece
			Overall Length	Hex Size	Largest Diameter	
			A	B	C	
1/4	HF-251-4MP-S	1/4-18	2.34	0.81	0.99	0.25
1/4	HF-251-6MP-S	3/8-18	2.37	0.81	0.99	0.26
3/8	HF-371-4MP-S	1/4-18	2.49	0.94	1.07	0.32
3/8	HF-371-6MP-S	3/8-18	2.52	0.94	1.07	0.30
3/8	HF-371-8MP-S	1/2-14	2.68	0.94	1.07	0.33

Standard Hose Barb

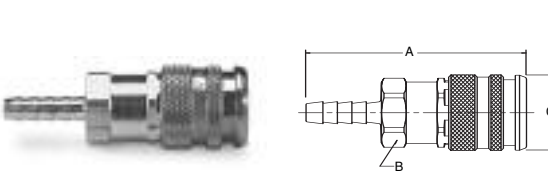

Body Size (in.)	Part No. Steel	Hose I.D.	Dimensions (in.)			Wt. (LB) P/Piece
			Overall Length	Hex Size	Largest Diameter	
			A	B	C	
1/4	HF-251-4HB-S	1/4	2.81	0.81	0.99	0.26
1/4	HF-251-6HB-S	3/8	2.81	0.81	0.99	0.27
3/8	HF-371-6HB-S	3/8	3.02	0.94	1.07	0.31
3/8	HF-371-8HB-S	1/2	3.02	0.94	1.07	0.34

Push-Lok Hose Barb

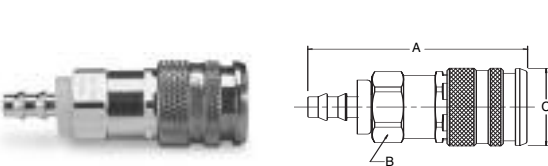

Body Size (in.)	Part No. Steel	Hose I.D.	Dimensions (in.)			Wt. (LB) P/Piece
			Overall Length	Hex Size	Largest Diameter	
			A	B	C	
1/4	HF-251-4PL-S	1/4	2.64	0.81	0.99	0.26
1/4	HF-251-6PL-S	3/8	2.78	0.81	0.99	0.27
3/8	HF-371-6PL-S	3/8	3.02	0.94	1.07	0.33
3/8	HF-371-8PL-S	1/2	3.07	0.94	1.07	0.31



Features

- Parker Industrial Interchange nipples are for use with any Parker HF Series.
- Parker Industrial Interchange nipples are interchangeable with similar nipples manufactured by other quick coupling manufacturers conforming to MIL-C4109 or ANSI/(NFPA) T3.20.14-1990 requirements. 1/8" body sizes are European profile.
- Hardened wear points** and solid barstock construction provide long service life.
- Precision machined surfaces and hardened load-bearing areas** resist the effects of mechanical shock in the most rugged applications.
- The HF Series and E-z-mate couplers that mate with the Industrial Interchange nipples are located in their respective coupling "Type" (e.g. Manual Type) as noted in the Table of Contents.

** steel nipples only

Female Pipe Thread

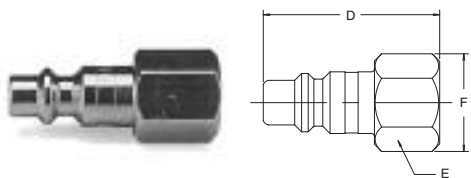

Body Size (in.)	Part No. Brass	Part No. Steel	Thread Size NPTF	Overall Length	Dimensions (in.)			Wt. (LB.) P/Piece
					D	E	F	
1/8	HF-124-2FP	-	1/8-27	1.08	0.50	0.58	.03	
1/8	HF-124-4FP	-	1/4-18	1.34	0.67	0.78	.07	
1/4	-	H1C	1/8-27	1.48	0.50	0.58	0.03	
1/4	BH3C	-	1/4-18	1.56	0.62	0.72	0.05	
1/4	-	H3C	1/4-18	1.56	0.62	0.72	0.05	
1/4	-	H3C-E	3/8-18	1.60	0.81	0.94	0.08	
3/8	-	H1E	1/4-18	1.60	0.62	0.72	0.06	
3/8	BH3E	-	3/8-18	1.69	0.81	0.94	0.10	
3/8	-	H3E	3/8-18	1.69	0.81	0.94	0.10	
3/8	-	H3E-F	1/2-14	1.84	1.00	1.16	0.13	
1/2	-	H1F	3/8-18	2.03	0.81	0.94	0.12	
1/2	BH3F	H3F	1/2-14	2.20	1.00	1.16	0.19	
1/2	-	H3F-G	3/4-14	2.30	1.25	1.44	0.26	

Male Pipe Thread

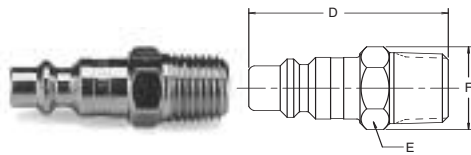

Body Size (in.)	Part No. Brass	Part No. Steel	Thread Size NPTF	Overall Length	Dimensions (in.)			Wt. (LB.) P/Piece
					D	E	F	
1/8	HF-124-2MP	-	1/8-27	1.06	0.44	0.51	0.03	
1/8	HF-124-4MP	-	1/4-18	1.25	0.56	0.63	0.05	
1/4	-	H0C	1/8-27	1.68	0.50	0.58	0.05	
1/4	BH2C	-	1/4-18	1.66	0.56	0.65	0.06	
1/4	-	H2C	1/4-18	1.66	0.56	0.65	0.06	
1/4	-	H2C-E	3/8-18	1.90	0.69	0.80	0.07	
3/8	-	H00E	1/8-27	1.68	0.62	0.72	0.08	
3/8	-	H0E	1/4-18	1.90	0.62	0.72	0.08	
3/8	BH2E	-	3/8-18	1.90	0.69	0.80	0.09	
3/8	-	H2E	3/8-18	1.90	0.69	0.80	0.09	
3/8	-	H2E-F	1/2-14	2.03	0.88	1.02	0.15	
1/2	-	H0F	3/8-18	2.20	0.69	0.79	0.16	
1/2	BH2F	H2F	1/2-14	2.35	0.88	1.01	0.18	
1/2	-	H2F-G	3/4-14	2.40	1.06	1.22	0.24	

Quick Coupling Products

Standard Hose Barb

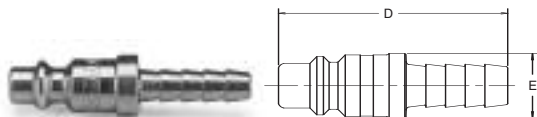

Body Size (in.)	Part No. Brass	Part No. Steel	Hose I.D.	Dimension (in.)		Wt. (LB.) P/Piece
				Overall Length	Largest Diameter	
				D	E	
1/4	–	H8C	1/4	2.09	0.46	0.04
1/4	–	H8C-D	5/16	1.96	0.50	0.04
1/4	–	H9C	3/8	1.96	0.50	0.05
3/8	–	H5E	3/8	1.85	0.59	0.07
3/8	–	H6E	1/2	2.09	0.68	0.08
1/2	–	H4F	3/8	2.36	0.66	0.10
1/2	–	H5F	1/2	2.36	0.66	0.11
1/2	–	H5F-G	3/4	2.95	0.87	0.18

Push-Lok Hose Barb**

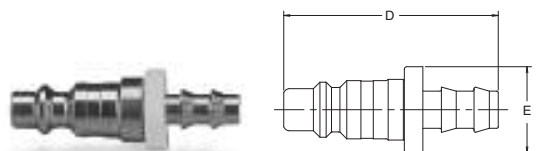

Body Size (in.)	Part No. Brass	Part No. Steel	Hose I.D.	Dimension (in.)		Wt. (LB.) P/Piece
				Overall Length	Largest Diameter	
				D	E	
1/4	BH8CP	–	1/4	1.74	0.69	0.04
1/4	–	H8CP	1/4	1.74	0.69	0.04
1/4	–	H9CP	3/8	1.96	0.86	0.05
3/8	–	H4EP	1/4	1.87	0.69	0.06
3/8	–	H5EP	3/8	2.02	0.86	0.07
3/8	–	H6EP	1/2	2.21	0.97	0.09
1/2	–	H4FP	3/8	2.36	0.86	0.11
1/2	–	H5FP	1/2	2.48	0.97	0.11
1/2	–	H6FP	5/8	2.95	1.14	0.14

**Push-Lok hose barbs are designed for use with Parker push-lok hose and do not require clamps.



Features

- Parker DM Series offer double shut-off valving and push-to-connect operation in a small envelope size.
- They are constructed of nickel plated brass and are available in 1/8" body size only.
- Standard seals are Fluorocarbon, but other seal material is available upon request. See the Coupling Selection and Ordering Information Guide at the beginning of Section A and the Fluid Compatibility Chart at the end of this catalog for optional materials.

Performance

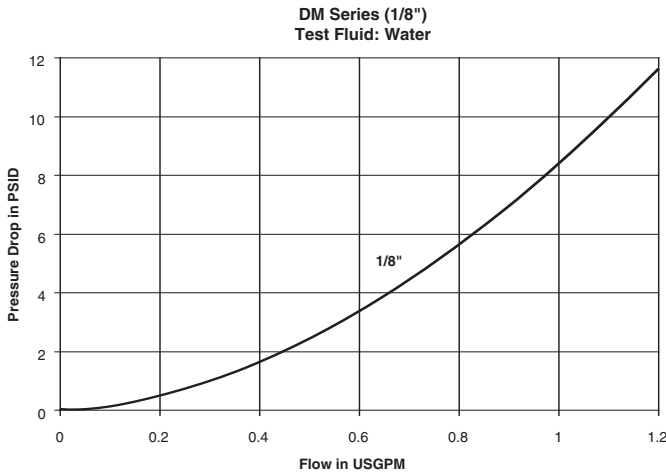

Applications

Typical applications include dental equipment, lubrication equipment, fluid transfer and coolant lines.

Specifications

Body Size (in.)	1/8"
Temperature Range	-15°F to +400°F
Rated Pressure	250 PSI
Locking Device	5 Balls
Rated Flow (GPM)	0.8

How To Order

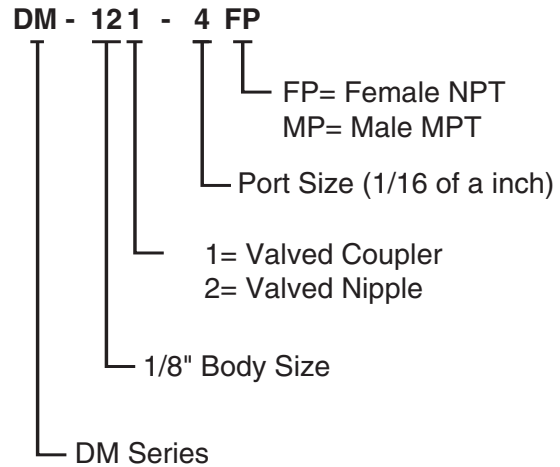

Quick Coupling Products

Double Shut-Off Couplings

DM Series

Couplers

Female Pipe Thread

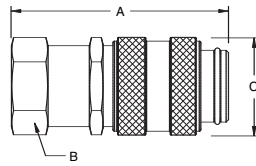

Body Size (in.)	Part No.	Thread Size NPTF	Dimensions (in.)			Wt. (LB) P/Price
			Overall Length	Hex Size	Largest Diameter	
			A	B	C	
1/8	DM-121-2FP	1/8-27	1.42	0.55	0.63	.06
1/8	DM-121-4FP	1/4-18	1.81	0.67	0.78	.10

Male Pipe Thread

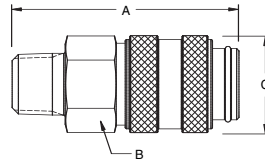

Body Size (in.)	Part No.	Thread Size NPTF	Dimensions (in.)			Wt. (LB) P/Price
			Overall Length	Hex Size	Largest Diameter	
			A	B	C	
1/8	DM-121-2MP	1/8-27	1.50	0.55	0.63	.06
1/8	DM-121-4MP	1/4-18	1.61	0.55	0.63	.07

Nipples

Female Pipe Thread

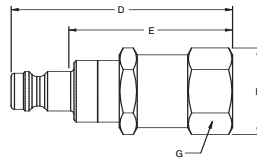

Body Size (in.)	Part No.	Thread Size NPTF	Dimensions (in.)				Wt. (lb) P/Price
			Overall Length	Exposed Length*	Hex Size	Largest Diameter	
			D	E	F	G	
1/8	DM-122-2FP	1/8-27	1.56	1.03	0.55	0.63	.05
1/8	DM-122-4FP	1/4-18	1.97	1.44	0.67	0.78	.09

* This dimension represents the portion that is exposed when a nipple is inserted into a Parker DM Series coupler.

Male Pipe Thread

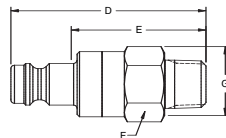

Body Size (in.)	Part No.	Thread Size NPTF	Dimensions (in.)				Wt. (lb) P/Price
			Overall Exposed Length	Exposed Length*	Hex Size	Largest Diameter	
			D	E	F	G	
1/8	DM-122-2MP	1/8-27	1.65	1.12	0.55	0.63	.05
1/8	DM-122-4MP	1/4-18	1.77	1.24	0.55	0.63	.06

* This dimension represents the portion that is exposed when a nipple is inserted into a Parker DM Series coupler.

Appendices

Quick Coupling Products

Fluid Compatibility Chart PF Series (Plastic/Polypropylene Material)

Ratings Code:

- G** – Good to excellent. Little or no swelling, tensile or surface changes. Preferred choice.
L – Marginal or conditional. Noticeable effects but not necessarily indicating lack of serviceability. Further testing suggested for specific application. Very long-term effects such as stiffening or potential for crazing should be evaluated.
P – Poor or unsatisfactory. Not recommended without extensive and realistic testing.
— – Indicates that this was not tested.
– For Teflon. Indicates good chemical resistance but potential for excessive permeation.

MEDIA	Polypropylene	MEDIA	Polypropylene
Acetaldehyde	P	Glucose	G
Acetates	L	GlycerineG	
Acetic Acid	G	Hydriodic Acid	-
Acetic Anhydride	L	Hydrochloric Acid (Conc.)	G
Acetone	G	Hydrochloric Acid (Med. Conc.)	G
Acetyl Bromide	-	Hydrofluoric Acid	G
Acetyl Chloride	L	Hydrogen Peroxide (Conc.)	L
Air	G	Hydrogen Peroxide (Dil.)	L
Alcohols	L	Hydrogen Sulfide	G
Aluminum Salts	G	Iodine	G
AmmoniaG		KeroseneP	
Amyl Acetate	L	Ketones	G
Aniline	G	Lacquer Solvent	L
Animal Oils	G	Lactic Acid	G
Arsenic Salts	L	Lead Acetate	G
Aromatic Hydrocarbons	-	Linseed Oil	G
Barium Salts	G	Magnesium Salts	G
Benzaldehyde	L	Naphtha L	L
Benzene (Benzol)	L	Natural Gas	L
Benzyl Alcohol	G	Nickel Salts	G
Bleaching Liquors	-	Nitric Acid (Conc.)	P
Boric Acid Solution	G	Nitric Acid (Dil.)	L
Bromine	P	Nitrobenzene	G
Butane	L	Nitrogen Oxides	-
Butanol	-	Nitrous Acid	G
Butyl Acetate	P	Oils (Animal and Mineral)	L
Calcium Salts	G	Oils (Vegetable)	L
Carbon Dioxide	G	Oxygen	L
Carbon Disulfide	L	Perchloric Acid	L
Carbon Tetrachloride	P	Phenol	G
Caustic Potash	G	Potassium Salts	G
Caustic Soda	G	Pyridine	G
Chloracetic Acid	L	Silver Nitrate	G
Chlorine (Dry)	P	Soap Solutions	G
Chlorine (Wet)	P	Sodium Salts	G
Chlorobenzene	P	Stearic Acid	L
Chloroform	P	Sulfur Chloride	P
Chromic Acid	G	Sulfuric Acid (Conc.)	L
Copper Salts	G	Sulfuric Acid (Dil.)	G
Cresol	L	Sulfurous Acid	L
Cyclohexanone	L	Tannic Acid	G
Ethers	P	Tanning Extracts	L
Ethyl Acetate	L	Titanium Salts	-
Ethyl Alcohol	G	Toluene (Toluol)	P
Ethylamine	L	Trichloroacetic Acid	G
Ethyl Bromide	-	Trichlorethylene	P
Ethyl Chloride	P	Turpentine	P
Fatty Acids	G	Urea	G
Ferric Salts	G	Uric Acid -	
Formaldehyde	G	Water	G
Formic Acid	G	Xylene (Xylol)	P
Freon	L	Zinc Chloride	G
Gasoline	L		

Quick Coupling Products

Codes

The following seal compound and body material compatibility chart is provided as an aid in selecting a specific synthetic rubber compound or body material for a particular application. Operating and environmental conditions must be considered when making the selection of a quick coupling.

Refer to Sections A (Pneumatics), B (Hydraulics) and C (Diagnostics) for Ordering Information for Seal Codes for specific products.

To indicate a special material just add the appropriate code letter as a suffix to the catalog number of the coupler. It is not necessary to use the code "STD" as the standard Nitrile seal will be used when another code is not used.

For recommendations for media not listed below, please contact your Parker representative or the factory.

Note

This chart is intended as a guide only and is not be considered as a recommendation to use Parker quick action couplings in a specific application or with a specific fluid, other factors that must be considered include but are not limited to: fluid and ambient temperature, system pressure, both operating and peak, frequency of connect and disconnect, and applicable standards or regulations.

CODES: 1 = Satisfactory 2 = Fair 3 = Not Recommended 4 = Insufficient Data Available

MEDIA	BODY MATERIAL				SEAL MATERIAL			
	Brass	Steel	316 S.S.	303 S.S.	Nitrile	E.P.	Fluorocarbon	Neoprene
3M FC-75	4	4	4	4	1	1	2	1
ACETAMIDE	4	4	1	2	1	1	3	1
ACETIC ACID (5%)	3	3	1	1	2	1	1	1
ACETONE	1	2	1	1	3	1	3	3
ACETOPHENONE	2	2	2	1	3	1	3	3
ACETYL ACETONE	2	2	2	2	3	1	3	3
ACETYL CHLORIDE	4	2	2	2	3	3	1	3
ACETYLENE	3	2	1	1	1	1	1	2
AIR (200 DEGREES F.)	1	2	1	1	1	1	1	1
AIR (300 DEGREES F.)	1	2	1	1	2	2	1	2
AIR (400 DEGREES F.)	1	2	1	1	3	3	1	3
ALUMINUM ACETATE	4	4	4	4	2	1	3	2
ALUMINUM BROMIDE	4	4	4	4	1	1	1	1
ALUMINUM CHLORIDE (10%)	3	3	3	3	1	1	1	1
ALUMINUM CHLORIDE (100%)	3	2	2	2	1	1	1	1
ALUMINUM FLUORIDE	3	3	3	3	1	1	1	1
ALUMINUM NITRATE	3	3	2	2	1	1	1	1
ALUMINUM SALTS	4	4	4	4	1	1	1	1
ALUMINUM SULPHATE	2	3	2	3	1	1	1	1
ALUMS (NH ₃ ,Cr,K)	4	4	4	4	1	1	3	1
AMMONIA (ANHYDROUS)	3	2	1	1	2	1	3	1
AMMONIA (COLD, GAS)	3	2	4	1	1	1	3	1
AMMONIA (HOT, GAS)	3	2	4	1	3	2	3	2
AMMONIUM CARBONATE	3	2	3	3	3	1	1	1
AMMONIUM CHLORIDE	3	3	2	3	1	1	1	1
AMMONIUM HYDROXIDE	3	3	1	2	3	1	3	1
AMMONIUM NITRATE	3	3	1	1	1	1	4	1
AMMONIUM PERSULFATE SOLUTION	3	3	1	2	3	1	4	4
AMMONIUM PHOSPHATE (MONO-, DI-, TRI-BASIC)	3	3	3	2	1	1	4	1
AMMONIUM SALTS	4	4	4	4	1	1	3	1
AMMONIUM SULFATE	3	3	2	3	1	1	3	1
AMYL BORATE	4	4	4	4	1	3	1	1
AMYL CHLORIDE	4	2	1	1	4	3	1	3
AMYL CHLORONAPHTHALENE	4	4	4	4	3	3	1	3
AMYL NAPHTHALENE	4	4	4	4	3	3	1	3
ANIMAL OIL (LARD OIL)	2	2	2	2	1	2	1	2
AROCLOR 1248	2	3	3	3	3	2	1	3
AROCLOR 1254	2	3	3	3	3	2	1	3
AROCLOR 1260	2	3	3	3	1	4	1	1

Fluid Compatibility Chart

Quick Coupling Products

CODES: 1 = Satisfactory 2 = Fair 3 = Not Recommended 4 = Insufficient Data Available

MEDIA	BODY MATERIAL				SEAL MATERIAL			
	Brass	Steel	316 S.S.	303 S.S.	Nitrile	E.P. Fluorocarbon	Neoprene	
AROMATIC FUEL - 50%	4	4	4	4	2	3	1	3
ARSENIC ACID	3	3	1	1	1	1	1	1
ASPHALT	3	3	1	1	2	3	1	2
ASTM OIL, NO. 1	1	1	1	1	1	3	1	1
ASTM OIL, NO. 2	1	1	1	1	1	3	1	2
ASTM OIL, NO. 3	1	1	1	1	1	3	1	3
ASTM OIL, NO. 4	1	1	1	1	2	3	1	3
ASTM REFERENCE FUEL A	3	2	1	1	1	3	1	2
ASTM REFERENCE FUEL B	3	2	1	1	1	3	1	3
ASTM REFERENCE FUEL C	3	2	1	1	2	3	1	3
AUTOMOTIVE BRAKE FLUID	4	4	4	4	3	1	3	2
BARIUM CHLORIDE	3	3	2	3	1	1	1	1
BARIUM HYDROXIDE	3	2	2	3	1	1	1	1
BARIUM SALTS	4	4	4	4	1	1	1	1
BARIUM SULFIDE	3	2	3	3	1	1	1	1
BEER	3	3	1	1	1	1	1	1
BEET SUGAR LIQUORS	3	3	1	1	1	1	1	2
BENZALDEHYDE	3	3	2	3	3	1	3	3
BENZENE	3	2	3	3	3	3	1	3
BENZENESULFONIC ACID (10%)	3	3	3	3	3	3	1	2
BENZINE	4	4	4	4	1	3	1	2
BENZOIC ACID	3	3	3	3	3	3	1	3
BENZYL ALCOHOL	4	3	1	2	3	2	1	2
BENZYL CHLORIDE	3	3	2	3	3	3	1	3
BLEACH LIQUOR	4	4	4	4	3	1	1	2
BORAX	3	2	3	3	2	1	1	3
BORDEAUX MIXTURE	4	4	4	4	2	1	1	2
BORIC ACID	3	3	2	3	1	1	1	1
BRAKE FLUID (NON-PETROLEUM)	4	4	4	4	3	1	3	2
BRINE (SODIUM CHLORIDE)	3	3	1	1	1	1	1	1
BROMINE	4	4	4	4	3	3	1	3
BROMINE WATER	4	4	4	4	3	2	1	3
BUNKER OIL	4	4	4	4	1	3	1	3
BUTADIENE (MONOMER)	3	2	1	2	3	3	1	3
BUTANE	3	1	1	1	1	3	1	1
BUTANE (2,2. & 2,3-DIMETHYL)	4	4	4	4	1	3	1	2
BUTANOL (BUTYL ALCOHOL)	2	1	1	1	1	2	1	1
BUTTER - ANIMAL FAT	2	3	1	2	1	1	1	2
BUTYL BUTYRATE	4	4	4	4	3	1	1	3
BUTYL STEARATE	4	4	4	4	2	3	1	3
CALCINE LIQUORS	4	4	4	4	1	1	1	4
CALCIUM ACETATE	4	4	4	4	2	1	3	2
CALCIUM BISULFITE	3	3	2	3	2	1	2	2
CALCIUM CARBONATE	3	2	3	2	1	1	1	1
CALCIUM CHLORIDE	3	3	2	3	1	1	1	1
CALCIUM HYDROXIDE	3	3	2	3	1	1	1	1
CALCIUM HYPOCHLORITE	3	3	2	3	2	1	1	2
CALCIUM SALTS	4	4	4	4	1	1	1	1
CALCIUM SULFIDE	3	3	2	2	1	1	1	1
CALICHE LIQUORS	4	4	4	4	1	1	1	1
CANE SUGAR LIQUORS	4	2	1	1	1	1	1	1
CARBON BISULPHIDE	4	4	4	4	3	3	1	3
CARBON DIOXIDE	1	2	1	1	1	1	1	1
CARBON DISULFIDE	2	2	2	2	3	3	1	3
CARBON MONOXIDE	1	1	1	1	1	1	1	2
CARBON TETRACHLORIDE	2	3	1	3	2	3	1	3
CARBONIC ACID	3	3	1	2	2	1	1	1
CASTOR OIL	1	1	1	1	1	2	1	1
CELLUGUARD	4	4	4	4	1	1	1	1
CELLULUBE (NOW FYRQUEL)	4	4	4	4	3	1	1	3
CHINA WOOD OIL (TUNG OIL)	2	2	1	1	1	3	1	2
CHLORINATED SALT BRINE	4	4	4	4	3	3	1	3
CHLORINATED SOLVENTS	4	4	4	4	3	3	1	3
CHLORO BENZENE	3	3	2	3	3	3	1	3
CHLORO BUTADIENE	4	4	4	4	3	3	1	3
CHLOROFORM	3	2	2	1	3	3	1	3

Fluid Compatibility Chart

Quick Coupling Products

CODES: 1 = Satisfactory 2 = Fair 3 = Not Recommended 4 = Insufficient Data Available

MEDIA	BODY MATERIAL				SEAL MATERIAL			
	Brass	Steel	316 S.S.	303 S.S.	Nitrile	E.P.	Fluorocarbon	Neoprene
CHLORPHENOL	4	4	4	4	3	3	1	3
COCOANUT OIL	4	4	4	4	1	3	1	3
COPPER CHLORIDE	4	4	4	4	1	1	1	2
COPPER SALTS	4	4	4	4	1	1	1	1
COPPER SULFATE	3	3	2	3	1	1	1	1
CORN OIL	2	1	1	1	1	3	1	3
COTTONSEED OIL	3	2	1	2	1	3	1	3
CREOSOLS	3	2	1	2	3	3	1	3
CREOSOTE	3	3	2	1	1	3	1	2
CRESYLIC ACID	4	2	1	2	3	3	1	3
CRUDE OIL	3	2	1	1	2	3	1	3
CUTTING OIL	4	1	1	1	1	3	1	2
DECANE	4	4	4	4	1	3	1	3
DENATURED ALCOHOL	4	4	4	4	1	1	1	1
DETERGENT, WATER SOLUTION	3	3	1	1	1	1	1	2
DIESEL FUEL	1	1	1	1	1	3	1	3
DIETHYLENE GLYCOL	3	1	1	1	1	1	1	1
DIMETHYL FORMAMIDE	4	4	1	1	2	1	3	3
DOW CHEMICAL HD50-4	4	4	4	4	4	1	3	2
DOW CORNING 200, 510, 550	4	4	4	4	2	1	1	1
DOWTHERM A,E	3	1	2	2	3	3	1	3
ETHANOL	1	3	3	3	3	1	3	1
ETHYL CHLORIDE	2	3	1	3	1	3	1	3
ETHYL HEXANOL	4	4	4	4	1	1	1	1
ETHYLENE DICHLORIDE	3	3	1	2	3	3	1	3
ETHYLENE GLYCOL	3	2	1	2	1	1	1	1
FATTY ACIDS	3	3	1	2	2	3	1	2
FREON 11	1	4	4	4	2	3	2	3
FREON 12	1	1	3	1	2	3	1	1
FREON 22	1	3	1	1	3	3	3	1
FUEL OIL	3	1	1	1	1	3	1	2
GALLIC ACID	3	3	2	2	2	2	1	2
GAS, LIQUID, PROPANE (LPG)	1	1	1	1	1	3	1	2
GAS, NATURAL	2	1	1	1	1	3	1	1
GASOLINE	1	2	1	1	1	3	1	3
GELATIN	3	3	1	1	1	1	1	1
GLUCOSE	1	1	1	1	1	1	1	1
GLYCERINE (GLYCEROL)	2	1	1	1	1	1	1	1
GLYCOLS	3	2	2	2	1	1	1	1
GREEN SULFATE LIQUOR	3	3	3	3	2	1	1	2
GULF - FR FLUID (EMULSION)	4	4	4	4	1	3	1	2
GULF - FR FLUID G	4	4	4	4	1	1	1	1
GULF - FR FLUID P	4	4	4	4	3	2	2	3
HELIUM	1	1	1	1	1	1	1	1
HEPTANE	1	1	1	1	1	3	1	2
HYDRAULIC OIL (PETROLEUM BASE)	1	1	1	1	1	3	1	1
HYDRAULIC OIL (WATER BASE)	4	1	1	1	2	1	3	2
HYDRAZINE	4	3	1	1	2	1	3	2
HYDROGEN GAS	1	1	1	1	1	1	1	1
HYDROLUBE	4	4	4	4	1	1	1	2
ISO OCTANE	1	1	1	1	1	3	1	2
ISOBUTYL ALCOHOL	4	4	1	1	2	1	1	1
ISOPROPYL ALCOHOL	1	1	2	1	2	1	1	2
ISOPROPYL ETHER	1	1	1	1	2	3	3	3
JP3 AND JP4	1	1	1	1	1	3	1	3
KEROSENE	1	1	1	1	1	3	1	2
LARD, ANIMAL FAT	1	1	1	1	1	2	1	2
LINSEED OIL	3	1	1	1	1	3	1	3
LUBRICATING OIL SAE 10, 20, 30, 40, 50	1	1	1	1	1	3	1	2
MAGNESIUM SALTS	4	4	4	4	1	1	1	1
MAGNESIUM SULPHATE	3	3	2	2	1	1	1	1
MERCURY	3	3	1	1	1	1	1	1
METHANE	1	3	1	1	1	3	1	2
METHANOL	1	1	1	1	1	1	3	1
METHYL BROMIDE	4	1	1	1	2	3	1	3
METHYL CHLORIDE (WET)	1	3	1	3	3	3	1	3

Fluid Compatibility Chart

Quick Coupling Products

CODES: 1 = Satisfactory 2 = Fair 3 = Not Recommended 4 = Insufficient Data Available

MEDIA	BODY MATERIAL				SEAL MATERIAL			
	Brass	Steel	316 S.S.	303 S.S.	Nitrile	E.P.	Fluorocarbon	Neoprene
METHYL CHLORIDE (DRY)	2	3	1	1	3	3	1	3
METHYL ETHER	4	4	4	4	1	3	1	3
METHYL ETHYL KETONE (MEK)	1	1	1	1	3	1	3	3
MIL-F-81912 (JP-9)	1	1	1	1	3	3	1	3
MIL-H-5606	1	1	1	1	1	3	1	2
MIL-H-6083	1	1	1	1	1	3	1	1
MIL-H-7083	1	1	1	1	1	1	2	2
MIL-H-8446 (MLO-8515)	2	1	1	1	2	3	1	1
MIL-L-2104 & 2104B	1	1	1	1	1	3	1	2
MIL-L-7808	3	2	1	1	2	3	1	3
MILK	2	1	1	1	1	1	1	1
MINERAL OILS	1	1	1	1	1	3	1	2
MLO-7277 AND MLO-7557	2	1	1	1	3	3	1	3
MOBILE HF	1	1	1	1	1	3	1	2
MONOMETHYL HYDRAZINE	4	4	4	4	2	1	4	2
NAPHTHA (COAL OR PETROLEUM)	2	1	2	2	2	3	1	3
NAPHTHALENE	2	1	2	2	3	3	1	3
NAPHTHENIC ACID	2	1	2	2	2	3	1	3
NEATSFOOT OIL	4	4	4	4	1	2	1	3
NICKEL, ACETATE	3	2	1	1	2	1	3	2
NICKEL CHLORIDE	3	3	2	2	1	1	1	2
NICKEL SALTS	4	4	4	4	1	1	1	2
NICKEL SULFATE	3	3	1	1	1	1	1	1
NITROGEN	1	1	1	1	1	1	1	1
NITROUS OXIDE	2	2	2	1	1	4	4	4
OCTYL ALCOHOL	1	1	1	1	2	3	1	2
OLIVE OIL	2	1	1	1	1	2	1	2
ORTHO-DICHLOROBENZENE	2	2	2	2	3	3	1	3
OXALIC ACID	3	3	2	1	2	1	1	2
OXYGEN (200-400 DEGREES F.)	1	1	1	1	3	3	2	3
OXYGEN, COLD	1	1	1	1	2	1	1	1
OZONE	3	3	1	1	3	1	1	3
PALMITIC ACID	1	2	1	1	1	2	1	2
PARA-DICHLOROBENZENE	2	1	1	2	3	3	1	3
PARKER O LUBE	1	1	1	1	1	3	1	1
PEANUT OIL	2	1	1	1	1	3	1	3
PENTANE (2-3-METHYL, & 2-4 DIMETHYL)	2	2	2	2	1	3	1	2
PERCHLORIC ACID -2N	3	3	2	2	3	2	1	2
PERCHLOROETHYLENE	3	2	2	2	2	3	1	3
PETROLATUM	1	1	1	1	1	3	1	2
PETROLEUM OIL, BELOW 250 DEGREES F.	1	1	1	1	1	3	1	2
PHENOL	1	1	1	1	3	3	1	3
PHOSPHORIC ACID (3 MOLAR)	3	3	2	2	1	1	1	2
PHOSPHORIC ACID (CONCENTRATED)	3	3	2	2	3	1	1	3
PHOSPHOROUS TRICHLORIDE	3	3	1	1	3	1	1	3
PICRIC ACID, MOLTEN	3	3	2	2	2	2	1	2
PICRIC ACID, WATER SOLUTION	3	3	2	2	1	1	1	1
PINE OIL	2	2	1	2	1	3	1	3
PLATING SOLUTIONS (CHROME)	1	3	1	1	4	1	1	3
PLATING SOLUTIONS (OTHER)	4	1	1	1	1	1	1	3
PNEUMATIC SERVICE	1	1	1	1	1	1	1	1
POTASSIUM ACETATE	2	1	2	2	2	1	3	2
POTASSIUM CHLORIDE	3	3	1	2	1	1	1	1
POTASSIUM CYANIDE	3	2	2	2	1	1	1	1
POTASSIUM DICHROMATE	3	1	2	2	1	1	1	1
POTASSIUM HYDROXIDE (50%)	3	2	1	2	2	1	3	2
POTASSIUM NITRATE	2	1	1	1	1	1	1	1
POTASSIUM SALTS	4	4	4	4	1	1	1	1
POTASSIUM SULFATE	3	2	1	1	1	1	1	1
PRL-HIGH TEMP. HYDR. OIL	4	4	4	4	2	3	1	2
PRODUCER GAS	2	1	1	1	1	3	1	2
PROPANE	1	1	1	1	1	3	1	2
PROPYL ACETATE	3	1	1	1	3	2	3	3
PROPYL ALCOHOL	1	1	1	1	1	1	1	1
PROPYLENE	1	1	1	1	3	3	1	3
PYDRAUL 10E	3	1	1	1	3	1	3	3

Fluid Compatibility Chart

Quick Coupling Products

CODES: 1 = Satisfactory 2 = Fair 3 = Not Recommended 4 = Insufficient Data Available

MEDIA	BODY MATERIAL				SEAL MATERIAL			
	Brass	Steel	316 S.S.	303 S.S.	Nitrile	E.P.	Fluorocarbon	Neoprene
PYDRAUL A-200, C SERIES	3	1	1	1	3	3	1	3
PYDRAUL, 3 SERIES	3	1	1	1	3	1	1	3
PYROGARD 42, 43, 53, 55 (PHOSPHATE ESTER)	4	4	4	4	3	1	1	3
PYROGARD D	4	4	4	4	1	3	3	2
SEA WATER (SALT WATER)	2	3	1	1	1	1	1	2
SHELL IRUS 905	4	4	4	4	1	3	1	2
SILICONE GREASES	1	1	1	1	1	1	1	1
SILVER NITRATE	3	3	1	2	2	1	1	1
SKYDROL 500, TYPE 2	3	1	1	1	3	1	3	3
SKYDROL 7000, TYPE 2	3	1	1	1	3	1	2	3
SOAP SOLUTIONS	3	3	1	1	1	1	1	2
SODIUM ACETATE	1	1	1	1	2	1	3	2
SODIUM BICARBONATE (BAKING SODA)	2	2	1	1	1	1	1	1
SODIUM BISULPHATE OR BISULPHITE	3	3	2	1	1	1	1	1
SODIUM BORATE	3	2	2	2	1	1	1	1
SODIUM CARBONATE (SODA ASH)	4	1	1	1	1	1	1	1
SODIUM CHLORIDE	3	2	2	2	1	1	1	1
SODIUM CYANIDE	3	1	1	1	1	1	4	1
SODIUM HYDROXIDE (CAUSTIC SODA, LYE)	3	2	1	2	2	1	2	2
SODIUM HYDROXIDE, 50%	3	3	1	2	2	1	2	2
SODIUM METAPHOSPHATE	2	1	2	2	1	1	1	2
SODIUM NITRATE	3	2	1	1	2	1	4	2
SODIUM PERBORATE	3	3	1	1	2	1	1	2
SODIUM PEROXIDE	3	1	2	2	2	1	1	2
SODIUM PHOSPHATES	1	3	2	1	1	1	1	2
SODIUM SALTS	4	4	4	4	1	1	1	2
SODIUM SULFATE	3	2	1	1	1	1	1	1
SODIUM SULFIDE AND SULFITE	3	3	2	3	1	1	1	1
SODIUM THIOSULFATE	3	3	1	2	2	1	1	1
SOYBEAN OIL	2	1	1	1	1	3	1	3
STANNOUS CHLORIDE (15%)	3	3	2	3	1	1	1	1
STEAM, BELOW 400 DEGREEEES F.	1	3	1	1	3	1	3	3
STODDARD SOLVENT	2	1	1	1	1	3	1	2
SUCROSE SOLUTIONS	1	1	1	1	1	1	1	2
SULFUR	2	1	1	1	3	1	1	1
SULFUR LIQUORS	1	1	1	1	2	2	1	2
SULFUR (MOLTEN)	3	3	1	1	3	3	1	3
SULFUR DIOXIDE (DRY)	3	1	1	3	3	1	3	3
SULFUR TRIOXIDE (DRY)	2	2	2	3	3	2	1	3
SUNSAFE	3	1	1	1	1	3	1	2
TANNIC ACID (10%)	1	3	2	3	1	1	1	2
TAR, BITUMINOUS	2	1	1	1	2	3	1	3
TARTARIC ACID	2	3	3	2	1	2	1	2
TERPINEOL	4	4	4	4	2	3	1	3
TERTIARY BUTYL ALCOHOL	1	1	1	1	2	2	1	2
TETRACHLOROETHANE	4	2	1	2	3	3	1	3
TETRACHLOROETHYLENE	3	2	2	4	3	3	1	3
TETRAETHYL LEAD	1	1	1	1	2	3	1	2
TETRAETHYL LEAD (BLEND)	1	1	1	1	2	3	1	3
TITANIUM TETRACHLORIDE	2	1	2	3	2	3	1	3
TOLUENE	1	1	1	1	3	3	1	3
TRANSFORMER OIL	1	1	1	1	1	3	1	2
TRANSMISSION FLUID (TYPE A)	1	1	1	1	1	3	1	2
TRICHLOROETHANE	4	2	1	4	3	3	1	3
TRICHLOROETHYLENE	3	2	2	2	3	3	1	3
TRICRESYL PHOSPHATE	4	1	2	2	3	1	2	3
TURBINE OIL #15 (MIL-L-7808A)	4	2	1	1	2	3	1	3
TURPENTINE	3	2	1	1	1	3	1	3
VARNISH	1	1	1	1	2	3	1	3
WATER	1	3	1	1	1	1	2	2
WHISKEY	1	3	1	1	1	1	1	1
WINE	1	3	1	1	1	1	1	1
WOOD OIL	4	2	1	1	1	3	1	2
XYLENE	1	2	1	1	3	3	1	3
ZINC SULFATE	3	3	2	2	1	1	1	1

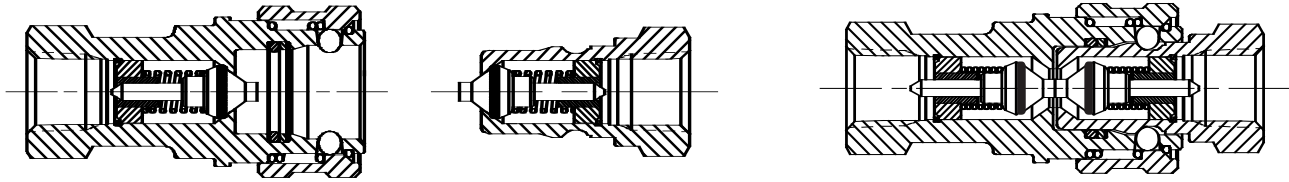

Air Inclusion

The ambient atmosphere forced into the system during the connection of the quick disconnect halves.

Break-Away

Automatic disconnection of a coupling when an axial separation force is applied.

Brinelling

Dimples or grooves worn into the shoulder of a male half by the locking balls in the female half.

Burst Pressure

The pressure at which a device loses the capability to retain pressure.

Case Hardening

Hardening the surface of low carbon steel..

Cold Flow

Continued deformation under load.

Connect Under Pressure

Ability to connect coupling halves with internal line pressure applied to either both sides or one side.

Coupling, Female Half

Other nomenclature “coupler”, “socket”, “body”.

Coupling, Male Half

Other nomenclature “nipple”, “plug”, “adapter”.

Coupling, Quick Disconnect

A component which can quickly join or separate a fluid line without the use of tools or special devices.

Differential Pressure(ΔP)

The difference in pressure between any two points of a system or a component.

Double-Acting Sleeve.

Permits push-to-connect and pull-to-disconnect convenience on implement line when female half is clamp mounted and connected with a hose.

Dust Cap

Dust or dirt repelling enclosure for both halves.

Dust Plug

Dust or dirt repelling enclosure both halves.

Flow Checking.

Occurs when a nipple valve closes during flow conditions, such as when quickly lowering a heavy implement. (Also called Check Off, Back Checking or Lock-up.)

Flush Position (Valve)

When the coupler valve is fully open, allowing maximum oil flow.

Force to Connect

Axial and/or rotational force required to make a complete connection.

Force to Disconnect

The reverse of the above.

Induction Hardening.

Localized hardening of medium carbon steel.

Peak Pressure

Maximum momentary pressure encountered in the operation of a component.

Pressure Cap

Cap which incorporates a seal capable of withstanding the rated pressures on the male half.

Pressure Impulse Test

Subjecting a component to a specified pressure at a specified rate of increase or decrease for a specified time limit.

Pressure Operating

The pressure at which a system is operated.

Pressure Plug

Plug which incorporates a seal capable of withstanding the rated pressures on the female half.

Proof Pressure

The non-destructive test pressure in excess of the maximum rated operating pressure.

Push To Connect (Auto Lock)

Locking arrangement which permits one handed connection by pushing the nipple into the coupler.

Rated Pressure

The maximum pressure at which a product is designed to operate.

Single-Acting Sleeve

Permits pull-to-disconnect convenience on implement line when female body is clamp mounted. Making connection requires manually pulling female body forward, inserting male tip, then allowing body and tip to return to original position in the clamp.

Sleeve Lock

Arrangement which provides an additional lock which must be actuated before the locking sleeve can be retracted.

Spillage

The fluid removed from the system due to disconnection of a coupling assembly. This is the fluid trapped between the mating seal and the valve seal of the coupling halves.

Surge Pressure

The pressure existing from surge conditions.

Surge Flows

A rapid increase in fluid flow.

Thermal Build-Up.

Hydraulic pressure caused by expansion of the fluid due to heat from an external source such as sunlight.

Trapped Pressure

Pressurized hydraulic fluid trapped behind closed coupling valve

Twist Lock

A locking arrangement which requires a rotational actuation to unlock the mating halves.

Types of Quick Disconnect Coupling Valves

Straight-Thru (ST)

This provides straight through flow.

Double Shut-off Valve (DSO)

A valve in the female half and a valve in the male half.

Single Shut-off Valve (SSO)

Generally, a valve in the female half with no valve in the male half.

SAFETY GUIDE FOR SELECTING AND USING QUICK ACTION COUPLINGS AND RELATED ACCESSORIES

DANGER: Failure or improper selection or improper use of quick action couplings or related accessories can cause death, personal injury and property damage. Possible consequences of failure or improper selection or improper use of quick action couplings or related accessories include but are not limited to:



- Couplings or parts thrown off at high speed.
- High velocity fluid discharge.
- Explosion or burning of the conveyed fluid.
- Contact with suddenly moving or falling objects that are to be held in position or moved by the conveyed fluid.
- Dangerously whipping hose.
- Contact with conveyed fluids that may be hot, cold, toxic, or otherwise injurious.
- Sparking or explosion while paint or flammable liquid spraying.

Before selecting or using any Parker quick action couplings or related accessories, it is important that you read and follow the following instructions.

1.1 Scope: This safety guide provides instructions for selecting and using (including installing connecting, disconnecting, and maintaining) quick action couplings and related accessories (including caps, plugs, blow guns, and two way valves). This safety guide is a supplement to and is to be used with, the specific Parker publications for the specific quick action couplings and related accessories that are being considered for use.

1.2 Fail-Safe: Quick action couplings or the hose they are attached to can fail without warning for many reasons. Design all systems and equipment in a fail-safe mode, so that failure of the quick action coupling or hose will not endanger persons or property.

1.3 Distribution: Provide a copy of this safety guide to each person that is responsible for selecting or using quick action coupling products. Do not select or use quick action couplings without thoroughly reading and understanding this safety guide as well as the specific Parker publications for the products considered or selected.

1.4 User Responsibility: Due to the wide variety of operating conditions and uses for quick action couplings, Parker and its distributors do not represent or warrant that any particular quick action coupling is suitable for any specific end use system. This safety guide does not analyze all technical parameters that must be considered in selecting a product. The user, through its own analysis and testing, is solely responsible for:

- Making the final selection of the quick action couplings.
- Assuring that the user's requirements are met and that the use presents no health or safety hazards.
- Providing all appropriate health and safety warnings on the equipment on which the quick action couplings are used.

1.5 Additional Questions: Call the appropriate Parker customer service department if you have any questions or require any additional information. For the telephone numbers of the appropriate customer service department, see the Parker publication for the product being considered or used.

2.0 QUICK ACTION COUPLING SELECTION INSTRUCTIONS

2.1 Pressure: Quick action couplings selection must be made so that the published rated pressure of the coupling is equal to or greater than the maximum system pressure. Surge pressures in the system higher than the rated pressure of the coupling will shorten the quick action coupling's life. Do not confuse burst pressure or other pressure values with rated pressure and do not use burst pressure or other pressure values for this purpose.

2.2 Fluid Compatibility: Quick action couplings selection must assure compatibility of the body and seal materials with the fluid media used. See the fluid compatibility chart in the Parker publication for the product being considered or used.

2.3 Temperature: Be certain that fluid and ambient temperatures, both steady and transient, do not exceed the limitations of the quick action couplings. Use caution and hand protection when connecting or disconnecting quick action couplings that are heated or cooled by the media they are conducting or by their environment.

2.4 Size: Transmission of power by means of pressurized liquid varies with pressure and rate of flow. The size of the quick action couplings and other components of the system must be adequate to keep pressure losses to a minimum and avoid damage due to heat generation or excessive fluid velocity.

2.5 Pressurized Connect or Disconnect: If connecting or disconnecting under pressure is a requirement, use only quick action couplings designed for that purpose. The rated operating pressure of a quick action coupling may not be the pressure at which it may be safely connected or disconnected.

2.6 Environment: Care must be taken to ensure that quick action couplings are either compatible with or protected from the environment (that is, surrounding conditions) to which they are exposed. Environmental conditions including but not limited to ultraviolet radiation, ozone, moisture, water, salt water, chemicals, and air pollutants can cause degradation and premature failure.

2.7 Locking Means: Ball locking quick action couplings can unintentionally disconnect if they are dragged over obstructions on the end of a hose or if the sleeve is bumped or moved enough to cause disconnect. Sleeves designed with flanges to provide better gripping for oily or gloved hands are especially susceptible to accidental disconnect and should not be used where these conditions exist. Sleeve lock or union (threaded) sleeve designs should be considered where there is a potential for accidental uncoupling.

2.8 Mechanical Loads: External forces can significantly reduce quick action couplings' life or cause failure. Mechanical loads which must be considered include excessive tensile or side loads, and vibration. Unusual applications may require special testing prior to quick action couplings selection.

2.9 Specifications and Standards: When selecting quick action couplings, government, industry, and Parker specifications must be reviewed and followed as applicable.

2.10 Vacuum: Not all quick action couplings are suitable or recommended for vacuum service. Quick action couplings used for vacuum applications must be selected to ensure that the quick actions couplings will withstand the vacuum and pressure of the system.

2.11 Fire Resistant Fluids: Some fire resistant fluids require seals other than the standard nitrile used in many quick action couplings.

2.12 Radiant Heat: Quick action couplings can be heated to destruction or loss of sealability without contact by such nearby items as hot manifolds or molten metal. The same heat source may then initiate a fire. This can occur despite the presence of cool air around the quick action couplings.

2.13 Welding and Brazing: Heating of plated parts, including quick action couplings and port adapters, above 450°F (232°C) such as during welding, brazing, or soldering may emit deadly gases and may cause coupling seal damage.

Quick Coupling Products

3.0 QUICK ACTION COUPLING INSTALLATION INSTRUCTIONS

3.1 Pre-Installation Inspection: Before installing a quick action coupling, visually inspect it and check for correct style, body material, seal material, and catalog number. Before final installation, coupling halves should be connected and disconnected with a sample of the mating half with which they will be used.

3.2 Quick Action Coupling Halves From Other Manufacturers: If a quick action coupling assembly is made up of one Parker half and one half from another manufacturer, the lowest pressure rating of the two halves should not be exceeded.

3.3 Fitting Installation: Use a thread sealant, lubricant, or a combination of both when assembling pipe thread joints in quick action couplings. Be sure the sealant is compatible with the system fluid or gas. To avoid system contamination, use a liquid or paste type sealant rather than a tape style. Use the flats provided to hold the quick action coupling when installing fittings. Do not use pipe wrenches or a vice on other parts of the coupling to hold it when installing or removing fittings as damage or loosening of threaded joints in the coupling assembly could result. Do not apply excessive torque to taper pipe threads because cracking or splitting of the female component can result.

3.4 Caps and Plugs: Use dust caps and plugs when quick action couplings are not coupled to exclude dirt and contamination and to protect critical surfaces from damage.

3.5 Coupling Location: Locate quick action couplings where they can be reached for connect or disconnect without exposing the operator to slipping, falling, getting sprayed, or coming in contact with hot or moving parts.

3.6 Hose Whips: Use a hose whip (a short length of hose between the tool and the coupling half) instead of rigidly mounting a coupling half on hand tools or other devices. This reduces the potential for coupling damage if the tool is dropped and provides some isolation from mechanical vibration which could cause uncoupling.

4.0 QUICK ACTION COUPLING MAINTENANCE INSTRUCTIONS

4.1 Even with proper selection and installation, quick action coupling life may be significantly reduced without a continuing maintenance program. Frequency should be determined by the severity of the application and risk potential. A maintenance program must be established and followed by the user and must include the following as a minimum:

4.2 Visual Inspection of Quick Action Couplings: Any of the following conditions require immediate shut down and replacement of the quick action coupling:

- Cracked, damaged, or corroded quick action coupling parts.
- Leaks at the fitting, valve or mating seal.
- Broken coupling mounting hardware, especially breakaway clamps.

4.3 Visual Inspection All Other: The following items must be tightened, repaired or replaced as required:

- Leaking seals or port connections.
- Remove excess dirt buildup on the coupling locking means or on the interface area of either coupling half.
- Clamps, guards, and shields.
- System fluid level, fluid type and any air entrapment.

4.4 Functional Test: Operate the system at maximum operating pressure and check for possible malfunctions and freedom from leaks. Personnel must avoid potential hazardous areas while testing and using the system.

4.5 Replacement Intervals: Specific replacement intervals must be considered based on previous service life, government or industry recommendations, or when failures could result in unacceptable downtime, damage or injury risk. See instruction 1.2 above.

Additional copies of the preceding safety information can be ordered by requesting "Safety Guide For Selecting and Using Quick Action Couplings and Related Accessories," Parker Publication No. 3800-B1.0

Contact The Quick Coupling Division, Minneapolis, MN.

Quick Coupling Products

The items described in this document are hereby offered for sale at prices to be established by Parker Hannifin Corporation, its subsidiaries and its authorized distributors. This offer and its acceptance by any customer ("Buyer") shall be governed by all of the following Terms and Conditions. Buyer's order for any item described in its document, when communicated to Parker Hannifin Corporation, its subsidiary or an authorized distributor ("Seller") verbally or in writing, shall constitute acceptance of this offer.

1. Terms and Conditions of Sale: All descriptions, quotations, proposals, offers, acknowledgments, acceptances and sales of Seller's products are subject to and shall be governed exclusively by the terms and conditions stated herein. Buyer's acceptance of any offer to sell is limited to these terms and conditions. Any terms or conditions in addition to, or inconsistent with those stated herein, proposed by Buyer in any acceptance of an offer by Seller, are hereby objected to. No such additional, different or inconsistent terms and conditions shall become part of the contract between Buyer and Seller unless expressly accepted in writing by Seller. Seller's acceptance of any offer to purchase by Buyer is expressly conditional upon Buyer's assent to all the terms and conditions stated herein, including any terms in addition to, or inconsistent with those contained in Buyer's offer. Acceptance of Seller's products shall in all events constitute such assent.

2. Payment: Payment shall be made by Buyer net 30 days from the date of delivery of the items purchased hereunder. Amounts not timely paid shall bear interest of 1% for each month or a portion thereof that Buyer is late in making payment. Any claims by Buyer for omissions or shortages in a shipment shall be waived unless Seller receives notice thereof within 30 days after Buyer's receipt of the shipment.

3. Delivery: Unless otherwise provided on the face hereof, delivery shall be made F.O.B. Seller's plant. Regardless of the method of delivery, however, risk of loss shall pass to Buyer upon Seller's delivery to a carrier. Any delivery dates shown are approximate only and Seller shall have no liability for any delays in delivery.

4. Warranty: Seller warrants that the items sold hereunder shall be free from defects in material or workmanship for a period of 365 days from the date of shipment to Buyer. **THIS WARRANTY COMPRISES THE SOLE AND ENTIRE WARRANTY PERTAINING TO ITEMS PROVIDED HEREUNDER. SELLER MAKES NO OTHER WARRANTY, GUARANTEE, OR REPRESENTATION OF ANY KIND WHATSOEVER. ALL OTHER WARRANTIES, INCLUDING BUT NOT LIMITED TO, MERCHANTABILITY AND FITNESS FOR PURPOSE, WHETHER EXPRESS, IMPLIED, OR ARISING BY OPERATION OF LAW, TRADE USAGE, OR COURSE OF DEALING ARE HEREBY DISCLAIMED.** NOTWITHSTANDING THE FOREGOING, THERE ARE NO WARRANTIES WHATSOEVER ON ITEMS BUILT OR ACQUIRED WHOLLY OR PARTIALLY, TO BUYER'S DESIGNS OR SPECIFICATIONS.

5. Limitation Of Remedy: SELLER'S LIABILITY ARISING FROM OR IN ANY WAY CONNECTED WITH THE ITEMS SOLD OR THIS CONTRACT SHALL BE LIMITED EXCLUSIVELY TO REPAIR OR REPLACEMENT OF THE ITEMS SOLD OR REFUND OF THE PURCHASE PRICE PAID BY BUYER, AT SELLER'S SOLE OPTION. IN NO EVENT SHALL SELLER BE LIABLE FOR ANY INCIDENTAL, CONSEQUENTIAL OR SPECIAL DAMAGES OF ANY KIND OR NATURE WHATSOEVER, INCLUDING BUT NOT LIMITED TO LOST PROFITS ARISING FROM OR IN ANY WAY CONNECTED WITH THIS AGREEMENT OR ITEMS SOLD HEREUNDER, WHETHER ALLEGED TO ARISE FROM BREACH OF CONTRACT, EXPRESS OR IMPLIED WARRANTY, OR IN TORT, INCLUDING WITHOUT LIMITATION, NEGLIGENCE, FAILURE TO WARN OR STRICT LIABILITY.

6. Changes, Reschedules and Cancellations: Buyer may request to modify the designs or specifications for the items sold hereunder as well as the quantities and delivery dates thereof, or may request to cancel all or part of this order, however, no such requested modification or cancellation shall become part of the contract between Buyer and Seller unless accepted by Seller in a written amendment to this Agreement. Acceptance of any such requested modification or cancellation shall be at Seller's discretion, and shall be upon such terms and conditions as Seller may require.

7. Special Tooling: A tooling charge may be imposed for any special tooling, including without limitation, dies, fixtures, molds and patterns, acquired to manufacture items sold pursuant to this contract. Such special tooling shall be and remain Seller's property notwithstanding payment of any charges therefore by Buyer. In no event will Buyer acquire any interest in apparatus belonging to Seller which is utilized in the manufacture of the items sold hereunder, even if such apparatus has been specially converted or adapted for such manufacture and notwithstanding any charges paid by Buyer therefore. Unless otherwise agreed, Seller shall have the right to alter, discard or otherwise dispose of any special tooling or other property in its sole discretion at any time.

8. Buyer's Property: Any designs, tools, patterns, materials, drawings, confidential information or equipment furnished by the Buyer or any other items which become Buyer's property, may be considered obsolete and may be destroyed by Seller after two (2) consecutive years have elapsed without Buyer placing an order for the items which are manufactured using such property. Seller shall not be responsible for any loss or damage to such property while it is in Seller's possession or control.

9. Taxes: Unless otherwise indicated on the face hereof, all prices and charges are exclusive of excise, sales, use, property, occupational or like taxes which may be imposed by any taxing authority upon the manufacture, sale or delivery of the items sold hereunder. If any such taxes must be paid by Seller or if Seller is liable for the collection of such tax, the amount thereof shall be in addition to the amounts for the items sold. Buyer agrees to pay all such taxes or to reimburse Seller therefore upon receipt of its invoice. If Buyer claims exemption from any sales, use or other tax imposed by any taxing authority, Buyer shall save Seller harmless from and against any such tax, together with any interest or penalties thereon which may be assessed if the items are held to be taxable.

10. Indemnity For Infringement of Intellectual Property Rights: Seller shall have no liability for infringement of any patents, trademarks, copyrights, trade dress, trade secrets or similar rights except as provided in this Part 10. Seller will defend and indemnify Buyer against allegations of infringement of U.S. patents, U.S. trademarks, copyrights, trade dress and trade secrets (hereinafter "Intellectual Property Rights"). Seller will defend at its expense and will pay the cost of any settlement or damages awarded in an action brought against Buyer based on an allegation that an item sold pursuant to this contract infringes the Intellectual Property Rights of a third party. Seller's obligation to defend and indemnify Buyer is contingent on Buyer notifying Seller within ten (10) days after Buyer becomes aware of such allegations of infringement, and Seller having sole control over the defense of any allegations or actions including all negotiations for settlement or compromise. If an item sold hereunder is subject to a claim that it infringes the Intellectual Property Rights of a third party, Seller may, at its sole expense and option, procure for Buyer the right to continue using said item, replace or modify said item so as to make it noninfringing, or offer to accept return of said item and return the purchase price less a reasonable allowance for depreciation. Notwithstanding the foregoing, Seller shall have no liability for claims of infringement based on information provided by Buyer, or directed to items delivered hereunder for which the designs are specified in whole or part by Buyer, or infringements resulting from the modification, combination or use in a system of any item sold hereunder. The foregoing provisions of this Part 10 shall constitute Seller's sole and exclusive liability and Buyer's sole and exclusive remedy for infringement of Intellectual Property rights.

If a claim is based on information provided by Buyer or if the design for an item delivered hereunder is specified in whole or in part by Buyer, Buyer shall defend and indemnify Seller for all costs, expenses or judgments resulting from any claim that such item infringes any patent, trademark, copyright, trade dress, trade secret or any similar right.

11. Force Majeure: Seller does not assume the risk of and shall not be liable for delay or failure to perform any of Seller's obligations by reason of circumstances beyond the reasonable control of Seller (hereinafter "Events of Force Majeure"). Events of Force Majeure shall include without limitation, accidents, acts of God, strikes or labor disputes, acts, laws, rules or regulations of any government or government agency, fires, floods, delays or failures in delivery of carriers or suppliers, shortages of materials and any other cause beyond Seller's control.

12. Entire Agreement/Governing Law: The terms and conditions set forth herein, together with any amendments, modifications and any different terms or conditions expressly accepted by Seller in writing, shall constitute the entire Agreement concerning the items sold, and there are no oral or other representations or agreements which pertain thereto. This Agreement shall be governed in all respects by the law of the State of Ohio. No actions arising out of the sale of the items sold hereunder or this Agreement may be brought by either party more than two (2) years after the cause of action accrues.



Parker Microelectronics Divisions

North America

Instrumentation Products Divisions

Connectors Operation

1005 A Cleaner Way
Huntsville, AL 35805
Phone: (256) 885-3800
Fax: (256) 881-5072
www.parker.com/ipdus

Valve Operation

2651 Alabama Highway 21 North
Jacksonville, AL 36265
Phone: (256) 435-2130
Fax: (256) 435-7718
www.parker.com/ipdus

Europe

Riverside Road

Pottington Business Park
Barnstaple, Devon EX31 1NP
Phone: (44) 1271-313131
Fax: (44) 1271-373636
www.parker.com/ipd

Porter Instrument Division

245 Township Line Road
Hatfield, PA 19440
Phone: (215) 723-4000
Fax: (215) 723-2199
www.parker.com/porterinstrument

Quick Coupling Division

8145 Lewis Road
Minneapolis, MN 55427
Phone: (763) 544-7781
Fax: (763) 544-3418
www.parker.com/quickcouplings

Veriflo Division

250 Canal Boulevard
Richmond, CA 94804
Phone: (510) 235-9590
Fax: (510) 232-7396
www.parker.com/veriflo

Veriflo Division Partek Operation

7075 East Southpoint Road
Tucson, AZ 85706
Phone: (520) 574-2600
Fax: (520) 574-2700
www.parker.com/partek

Parker Worldwide Product Information

U.S.: 1-800-C-Parker (1-800-272-7537)
Europe: 00-800-C-Parker-H (00800-27-27-5374)

